

# Operation & Maintenance Guide

## PowerStack Series



---

# All Rights Reserved

## **All Rights Reserved**

No part of this document can be reproduced in any form or by any means without the prior written permission of Sungrow Power Supply Co., Ltd (hereinafter "SUNGROW").

## **Trademarks**

**SUNGROW** and other SUNGROW trademarks used in this manual are owned by SUNGROW.

## **Software Licenses**

- It is prohibited to use data contained in firmware or software developed by SUNGROW, in part or in full, for commercial purposes by any means.
- It is prohibited to perform reverse engineering, cracking, or any other operations that compromise the original program design of the software developed by SUNGROW.

# About This Manual

This manual provides instructions mainly on the commissioning, troubleshooting, and daily maintenance of the energy storage system (ESS).

This manual takes the ST255CS-2H product, sold in markets following IEC standards, as an example. Products available in other regions are similar.

## Target Group

This manual is intended for operators in energy storage plants and qualified electrical technicians.

The installation must only be performed by qualified technical persons. Qualified technical persons must:

- Have received specialized trainings
- Read this manual thoroughly and understand the safety instructions related to operations
- Be familiar with local standards and relevant safety regulations of electrical systems

## How to Use This Manual

Read through this manual carefully before using the product, and keep it properly in an easy-to-reach place.

To increase customer satisfaction, the product and its manual will be updated and improved constantly. If the manual you have received is slightly inconsistent with the real product, it is probably owed to a product update. In such a case, the real product shall take precedence.

The manual may be updated and revised from time to time, however, there still might be slight deviations from the real product or errors. In such cases, the actual product you have purchased should take precedence. You can find the latest version of the manual at [support.sungrowpower.com](http://support.sungrowpower.com) or reach your sales for it.

The figures in this manual are for reference only. The actual product received may differ.

## Symbols in the Manual

To ensure the safety of life and property for users when using the product and to improve the efficiency of product use, the manual provides relevant information, which is highlighted by the following symbols.

Symbols used in this manual are listed below. Please review carefully for better use of this manual.

## **DANGER**

Indicates an imminently hazardous situation which, if not avoided, will result in death or serious injury.

## **WARNING**

Indicates a moderately hazardous situation which, if not avoided, will result in death or serious injury.

## **CAUTION**

Indicates a slightly hazardous situation which, if not avoided, may result in minor or moderate injury.

## **NOTICE**







Indicates a potential hazard which, if not avoided, will result in device malfunction or property damage.











“NOTE” indicates supplementary information, emphasis on specific points, or tips related to the use of the product that might help to solve your problems or save your time.

### **Signs on the Product**

Observe at all times the warning signs on the product, including:

<b>Sign</b>	<b>Definition</b>
	High voltages inside! Risk of electrical shock hazards when touching it.
	Protective earthing (PE) terminal. This terminal must be connected for reliable grounding to ensure the safety of the operator.
	Read the manual before performing any operation on the product.
	After the product is disconnected from external power sources, wait at least 5 minutes before touching any of its internal conductive parts.
	Danger! Do not work on the product when it carries voltage.
	Beware of heavy weights! Lifting the heavy object directly may cause back injury. Please lift it with the assistance of proper tools.

Sign	Definition
	Beware of explosion.
	Beware of corrosion.
	Do not dispose of it together with household waste.
	No fires.
	A nearby medical facility must be set up.
	If it gets in your eyes, flush your eyes immediately with running water or saline, and seek medical advice in time.
	Wear safety goggles.
	The product is recyclable.
	The lithium battery is recyclable.

# Contents

---

All Rights Reserved.....	I
About This Manual.....	II
<b>1 System Description.....</b>	<b>1</b>
1.1 System Introduction.....	1
1.2 System Configuration.....	1
1.3 Communication Architecture.....	3
<b>2 System Composition.....</b>	<b>5</b>
2.1 Batteries.....	5
2.2 DC/AC Power Converter Unit.....	6
2.3 Battery Supply Panel.....	8
2.4 Local Controller.....	9
2.5 Liquid Cooling System.....	11
2.6 Fire Suppression System.....	12
<b>3 Commissioning.....</b>	<b>15</b>
3.1 Inspection Before Powering on.....	15
3.2 Power-on Procedure.....	15
3.3 Preparation Before Operation.....	17
3.4 Commissioning.....	17
3.4.1 Communication Commissioning.....	17
3.4.2 Startup/Shutdown Commissioning.....	18
3.4.3 Charge-Discharge Cycle Test.....	19
<b>4 Routine Maintenance.....</b>	<b>21</b>
4.1 Precautions Before Maintenance.....	21
4.2 Cabinet Maintenance.....	23
4.2.1 Repair Exterior Damage.....	23
4.2.1.1 Clean Removable Dirt.....	23
4.2.1.2 Repair Finish Coat.....	24
4.2.1.3 Repair Primer and Finish Coat.....	27
4.2.2 Inspect Door Locks and Hinges.....	30
4.2.3 Inspect Sealing Strips.....	30
4.3 Battery Maintenance.....	30
4.3.1 Maintenance Precautions.....	30
4.3.2 Device Maintenance.....	32
4.4 Liquid Cooling System Maintenance.....	33

<b>5 Common Maintenance Operations</b> .....	35
5.1 Safety Precautions.....	35
5.2 Coolant Draining and Refilling.....	36
5.2.1 Overview of Liquid Cooling System.....	36
5.2.2 Coolant Replacement Interval.....	37
5.2.3 Safety Precautions.....	38
5.2.4 Overview of Maintenance Tooling.....	40
5.2.5 Drain Coolant.....	41
5.2.6 Refill Coolant.....	43
5.3 Replace Pack.....	45
5.3.1 Tooling Introduction.....	45
5.3.1.1 Liquid Cooling Maintenance Tooling.....	45
5.3.1.2 Transport Tooling.....	46
5.3.1.3 Other Tools.....	47
5.3.2 Replace Pack.....	49
5.3.2.1 Precautions.....	49
5.3.2.2 Site Requirements.....	50
5.3.2.3 Preparation.....	50
5.3.3 Set Up Maintenance Tooling.....	55
5.3.3.1 Initial Setup.....	55
5.3.3.2 Maintenance Tooling Adjustment.....	56
5.3.4 Mount New Pack.....	58
5.3.4.1 Remove Old Pack.....	59
5.3.4.2 Position New Pack.....	60
5.3.5 Follow-up Work.....	62
5.3.5.1 Install Pack Angle Brackets.....	62
5.3.5.2 Install Fuse.....	62
5.3.5.3 Connect Cables.....	64
5.3.5.4 Install Liquid Cooling Pipes.....	64
5.3.5.5 Power On System.....	65
5.3.5.6 Close Cabinet Door.....	65
5.4 Replace BSP.....	65
5.5 Replace DC/AC Power Converter Unit.....	68
5.6 Replace Liquid Cooling Unit.....	71
5.7 Replace BMU.....	73
5.8 Replace Fuse.....	77
<b>6 Troubleshooting</b> .....	79
6.1 Overview.....	79
6.2 DC/AC Power Converter Unit Troubleshooting.....	79
6.3 Battery Troubleshooting.....	99

6.4 LC Troubleshooting.....	105
<b>7 Appendix.....</b>	<b>107</b>
7.1 Terms.....	107
7.2 Quality Assurance.....	108
7.3 Contact Information.....	109



Model	Quantity (pcs)	Remark
ST510CS-4H	1	256S2P LFP batteries + SC125CX + BSP + FSS + LCS

The main electrical equipment inside the ESS is shown in the figure below, taking ST255CS-2H as an example.

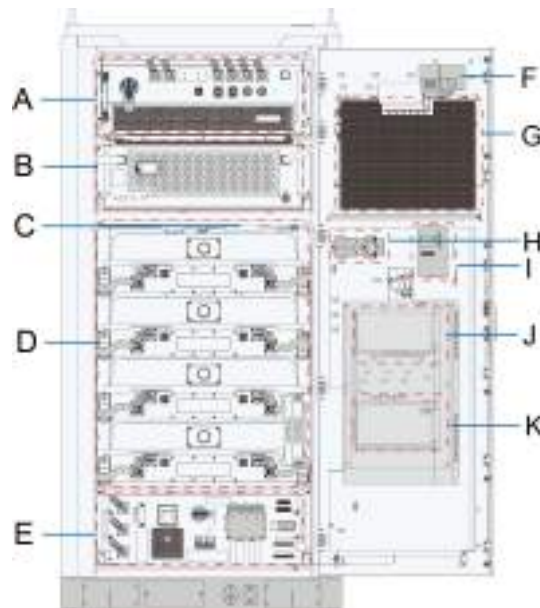

**Figure 1-2** Internal Structure

\*The figure is for reference only. The actual product may differ.

**Table 1-1** Internal Components

Item	Name
A	DC/AC power converter unit (SC125CX)
B	Liquid cooling unit
C	Fire suppression system (FSS)
D	Battery Rack (compartment)
E	Battery supply panel (BSP)
F	Alarm sounder
G	Stainless steel vent mesh
H	Aerosol

Item	Name
I	Dehumidifier
J	LC300
K	EMS300CP (optional)

The external view of the ESS is shown below.



\*The figure is for reference only. The actual product may differ.

### 1.3 Communication Architecture

The system is mainly composed of the EMS, LC, DC/AC power converter unit, CMU, and other components.

- Each LC collects data from the LCS, the batteries, the DC/AC power converter unit, and related I/O nodes (including UPS grid power input, SPD, system emergency stop, and compartment door access control status).
- All data within a single system is collected by the LC and then uploaded to the customer-side EMS. The LC also performs system protection, alarm management, data monitoring, and energy management functions.
- To cascade multiple systems, an additional SUNGROW EMS is required. The EMS communicates with the LC and supports data upload to the cloud for remote monitoring.

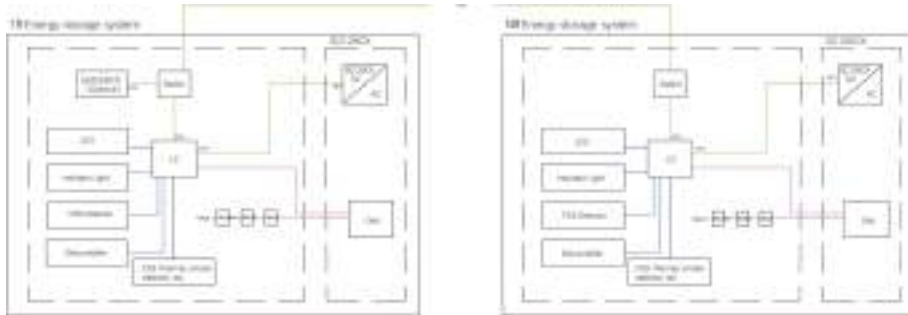

**Figure 1-3** Communication Architecture

\*The figure is for reference only. The actual product may differ.

## 2 System Composition

### 2.1 Batteries

Based on lithium iron phosphate (LFP) cells, standardized and modular battery Packs are developed, which are connected in series to form a Rack. The Rack is connected to the matching DC/AC power converter unit to constitute an ESS, enabling the storage and release of electrical energy.

#### Pack

**Table 2-1** Pack Data 1

Pack	Parameter	Value*
	Dimensions (W*H*D) (not including wiring terminals and faucets)	(868 ± 5 mm) * (247 ± 5 mm) * (1415 ± 5 mm)
	Charge/discharge rate	≤ 0.5P
	Cell type	Prismatic cell with aluminum shell, LFP
	Configuration (series and parallel)	1P64S
	Key components	64 cells, 1 BMU, 1 fuse (1P64S)
	Ingress protection rating	IP65

\*The data is for reference only.

**Table 2-2** Pack Data 2

Pack Model	Weight*
P0643AL-AHA / P0643BL-AHA P0643AL-AA-H / P0643BL-AA-H	(410 ± 6) kg
P0643AL-AMA / P0643BL-AMA	(413 ± 6) kg

Pack Model	Weight*
P0643AL-AA-M / P0643BL-AA-M	

\*The data is for reference only.

### Rack

The Rack is mainly composed of Packs and fuses.

Technical data of the Rack is shown in the table below.

**Table 2-3** Rack Data

Rack Model	DC Output Voltage Range	Rated Power	Rated Voltage	Short-Circuit Current
R0257BL-AHAA R0257BL-AAA-H R0257BL-AMAA R0257BL-AAA-M	691.2 V–934.4 V	128.6 kW	819.2 V	≤ 20 kA
R0514BL-AHCA R0514BL-ACA-H R0514BL-AMCA R0514BL-ACA-M	691.2 V–934.4 V	128.6 kW	819.2 V	≤ 20 kA

\*The data is for reference only.

## 2.2 DC/AC Power Converter Unit

The ESS is equipped with one SC125CX DC/AC power converter unit to monitor the Rack, manage energy transfer, and handle signal interactions.

The external view of the SC125CX is shown in the figure below.

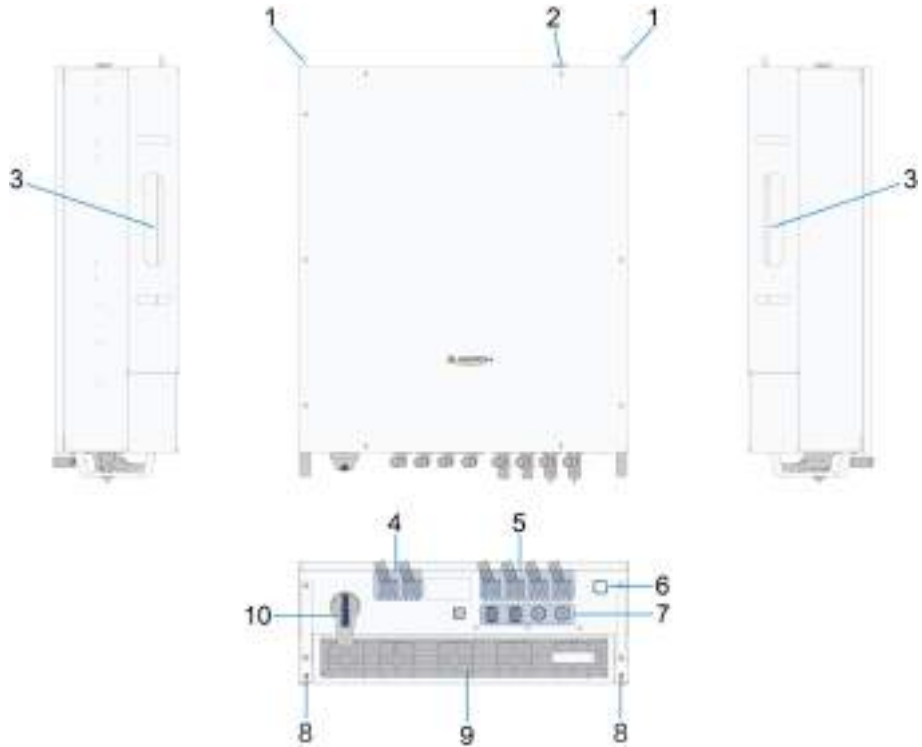

\*The figure is for reference only. The actual product may differ.

No.	Name	Description
1	Locating pin	Used to restrict the free movement of the DC/AC power converter unit.
2	Vent valve	Resistant to dust and water; air permeable.
3	Guide rail	Used for the transport, installation, and removal of the device.
4	Ports for DC wiring	Used for DC wiring of the device.
5	Ports for AC wiring	Used for AC wiring of the device.
6	LED indicator	Indicates the current operating status.
7	Ports for communication wiring	Used for communication wiring of the device.
8	*Additional grounding terminal	Used for additional protective grounding, as specified in EN 50178.

No.	Name	Description
9	Air inlet cover	Fans are installed at the back of the cover plate, used for forced cooling.
10	DC switch	Used to disconnect the device from the battery safely.

## 2.3 Battery Supply Panel

The ESS contains a battery supply panel (BSP). The main functions of the BSP are as follows:

- Connects the AC output of the DC/AC power converter unit to the customer side.
- Provides auxiliary power supplies for the system.
- Communicates with the LC via a network port for data transmission and liquid cooling unit control.

The external design of the BSP is shown in the figure below.

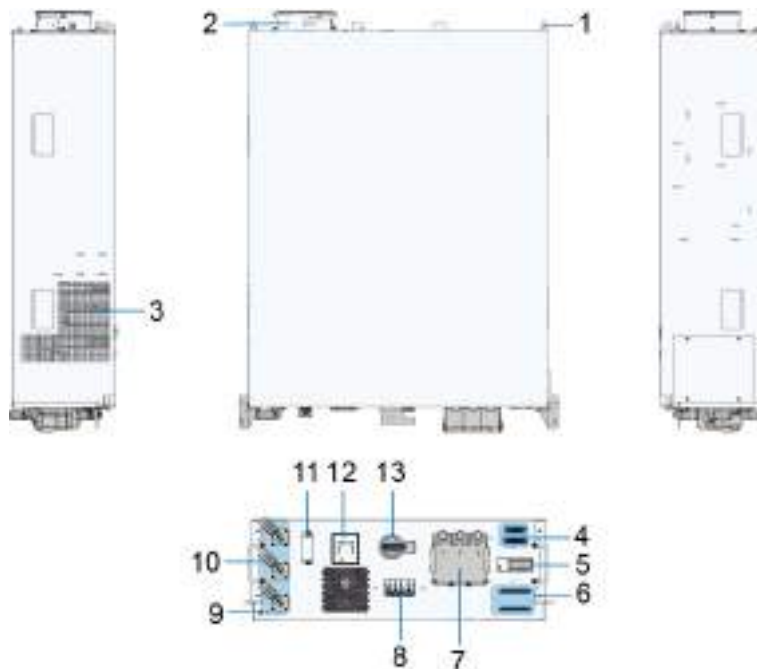

\*The figure is for reference only. The actual product may differ.

No.	Name	Description
1	Locating pin	Used to restrict the free movement of the BSP.
2	Air outlet	Used to exhaust the circulating hot air from the BSP.

No.	Name	Description
3	Air inlet	Used to bring circulating cool air into the BSP.
4	Connection ports 3-4	Used for power supply or communication wiring of the 24 Vdc device inside the cabinet.
5	Ethernet communication port	Used for communication wiring of the device.
6	Connection ports 1-2	Includes communication and 24 V power supply.
7	AC output port	AC output wiring area of the device.
8	Miniature circuit breaker	AC auxiliary power supply and UPS control switch.
9	Additional grounding terminal	Used for additional protective grounding, as specified by EN 50178.
10	AC input port	Connected to the AC side of the DC/AC power converter unit.
11	Liquid cooling unit power supply interface	Used for power supply wiring of the liquid cooling unit.
12	UPS	Uninterruptible power supply.
13	AC main switch	Used to disconnect the device from the loads safely.

\*The system is equipped with an internal power supply as standard.

## 2.4 Local Controller

The local controller (LC) primarily responds to dispatch commands from the upper computer, monitors system faults and alarms, collects data from sub-devices, and ensures safe and proper operation of the system. In addition, it manages and coordinates sub-devices such as the DC/AC power converter unit and batteries.

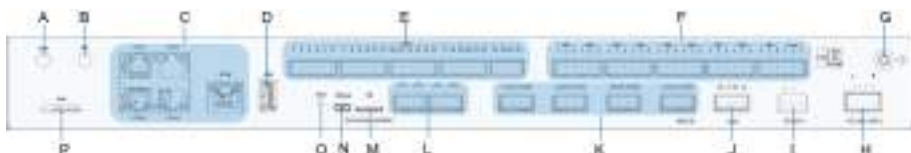

**Figure 2-1** Port Description

No.	Marking	Name	Description
A	WiFi	WiFi communication port	Reserved.
B	4G	4G communication port	Reserved.
C	ETH1–ETH5	Electrical Ethernet port	It can be connected to the background master station via switches, routers, or other devices, or used for lower-layer devices (configurable to connect PV inverters, DC/AC power converter units, etc.).
D	USB	USB port	Software update port.
E	DIN	Digital input	Dry contact input port.
F	DO1–DO10	Digital output	Relay output port. Relay specifications: 250 Vac/3 A or 30 Vdc/3 A.
G		Grounding point	Used to connect a protective grounding cable.
H	AC (110 V–240 V)	AC power supply port	Connected to 110 Vac–240 Vac (50 Hz/60 Hz), current $\leq 0.5$ A
I	DC (24V)	DC 24 V power supply port	Current $\leq 2.0$ A. The switch-mode power supply (SMPS) used for this port requires reinforced insulation.
J	CAN	CAN communication port	Reserved.
K	A1B1–A8B8	RS485 communication port	Supports 8 RS485 channels. It can be connected to slave devices or to the background.
L	PT1, PT2, AI1, AI2	Analog input	Reserved.
M	SD	SD card port	Reserved.

No.	Marking	Name	Description
N	Debug	Serial port for debugging	Used for controller debugging.
O	RST	Reset port	Used for hardware reset.
P	SIM	SIM card port	Reserved.

## 2.5 Liquid Cooling System

The liquid cooling system (LCS) is designed to provide cooling for the DC/AC power converter unit, liquid cooling unit, Packs, and BSP. The DC/AC power converter unit compartment and liquid cooling unit compartment use air cooling, the battery compartment uses liquid cooling, while the BSP compartment uses forced convection with the battery compartment.

- The DC/AC power converter unit and the liquid cooling unit share a common air inlet and use a front-inlet, rear-outlet airflow for forced air cooling.
- Coolant is transferred to the liquid cooling plates of the Packs through liquid cooling pipes, thereby enabling heat exchange for the battery system.
- The BSP is equipped with front and rear axial fans, which utilize heat leaks of the liquid cooling plates and pipes inside the battery compartment to facilitate heat exchange.

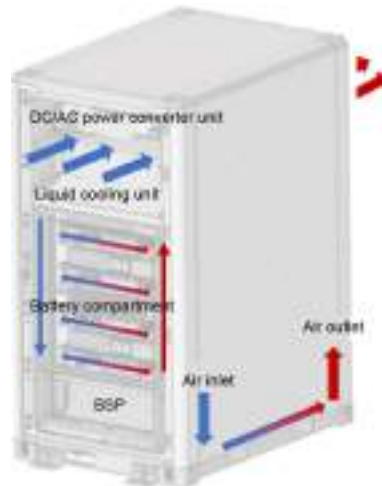

**Figure 2-2** Cooling System Schematic

\*The figure is for reference only. The actual product may differ.

The LCS is the core of the thermal management design for the entire ESS. It features a two-level piping system: the primary piping delivers coolant processed by the liquid cooling

unit to the secondary piping of each Pack, and the secondary piping distributes coolant to the liquid cooling plates of each Pack, thereby enabling cooling or heating of the Packs.

## 2.6 Fire Suppression System

Each ESS has a fire suppression system (FSS) that can function independently, without interfering with each other.

The FSS of the ESS includes a detection and alarm system, a fire extinguishing system, and a backup protection system (optional).

### NOTICE

**To ensure its accuracy, the combustible gas detector must be tested for functionality every six months. In case the detector fails the test, investigate the cause and calibrate the detector if necessary.**

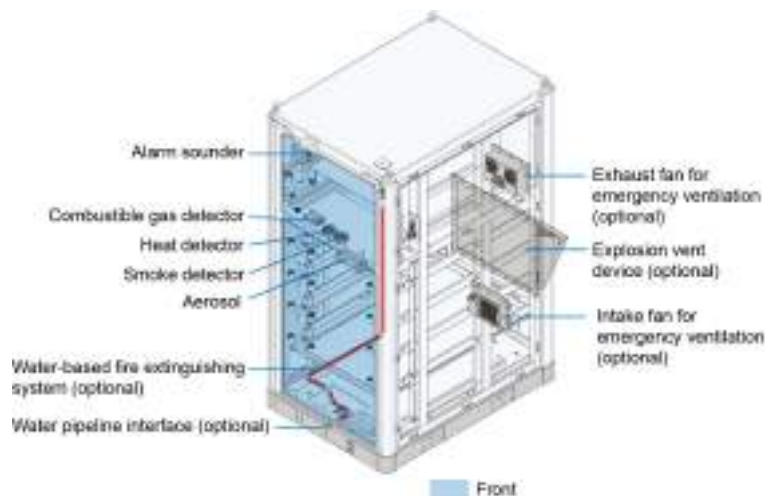

**Figure 2-3** FSS Equipment

\*The figure is for reference only. The actual product may differ.

**Table 2-4** Main Components of FSS

No.	Item	Introduction
1	Detection and alarm system	<p>The detection and alarm system is able to discover fires early in their development and thus helps to reduce the risk of fire to the minimum.</p> <p>Each ESS is equipped with a fire detection and alarm system consisting of a combustible gas detector, a smoke detector, a heat detector, and an alarm sander.</p> <ul style="list-style-type: none"> <li>The combustible gas detector monitors the concentration of combustible gases during a thermal</li> </ul>

No.	Item	Introduction
-----	------	--------------

runaway event. If the combustible gas concentration in the battery compartment reaches the preset alarm threshold, the combustible gas detector will trigger an alarm and upload the alarm signal to the LC.

- The smoke detector assesses the smoke concentration based on the scattering of light in smoke. When the smoke concentration in the battery compartment reaches the preset alarm threshold (0.15 dB/m), the smoke detector will trigger an alarm and upload the alarm signal to the LC.
- The heat detector senses the changes of temperature in the battery compartment. If the temperature in the battery compartment reaches the preset threshold (54°C), the heat detector will trigger an alarm and upload the alarm signal to the LC.
- In addition, if the LC also receives a cell overtemperature fault signal, the LC will shut down the current ESS.
- When both the smoke detector and heat detector trigger an alarm, under their linkage control, the alarm sounder will trigger an acoustic alarm to alert on-site personnel to the abnormal conditions in the equipment.

**NOTICE**

**When both the smoke and heat detector trigger an alarm, triggered by the linkage control mechanism, the aerosol fire extinguishing agent will be discharged. Before conducting tests, disconnect the activation line of the aerosol fire extinguishing system to prevent accidental activation.**

2 Fire extinguishing system

The FSS of the ESS is designed with hot aerosol fire extinguishing equipment.

- When both the smoke detector and heat detector trigger an alarm, under their linkage control, the aerosol generator will be activated, releasing smoke-like fire extinguishing agent. The fire extinguishing agent will then be discharged into the battery compartment through the nozzle on the enclosure to extinguish the fire.
- After the fire extinguishing agent is released, the feedback element will send a fire extinguishing agent

No.	Item	Introduction
		<p>release signal to the LC. In addition, if the LC also receives a cell overtemperature fault signal, the LC will shut down the current ESS.</p>
3	Backup protection system (optional)	<p>In addition to the fire extinguishing system, the ESS also has a backup protection system, in case the fire keeps spreading even after the fire extinguishing system has activated. In case the fire keeps spreading after the fire extinguishing system activates, the customer can activate the backup protection system after the ESS is powered off to extinguish the fire.</p> <p>Once the temperature around the sprinkler reaches 93°C, the glass bulb inside bursts, triggering the sprinkler to activate. Water then flows through the external and internal piping into the battery compartment, immersing the Packs, to cool the equipment down and extinguish the fire.</p> <p>The reserved interface has a DN25 pipe connector. The external piping system shall be designed and installed by the customer separately and properly connected to the reserved interface on the ESS.</p> <ul style="list-style-type: none"> <li>• Manual: Suitable for scenarios where fire trucks or other movable equipment are available at the site. In this scenario, set up a water supply piping system at the site in advance, with one side connected to the reserved interface of the ESS and the other side to the fire truck or other movable equipment. In case of a fire, people need to manually let the water in to extinguish the flames.</li> <li>• Automatic: Suitable for scenarios where fire water ponds are available at the site. In this scenario, the water supply piping system is connected to the reserved interface of the ESS on one side and to the pond on the other side. In case of a fire, water from the pond will automatically flow into the piping system for fire extinguishing. A valve must be installed on the pipe connected to the reserved interface on the ESS. Ensure that no water is present in the pipes inside the ESS under normal operating conditions.</li> </ul>

# 3 Commissioning

## 3.1 Inspection Before Powering on

### Personnel Requirements

- Personnel involved in on-site commissioning must not have significant physical or sensory impairments. Operators performing electrical operations must receive training organized by relevant departments, pass the corresponding examinations, and obtain an appropriate certification recognized by the national labor safety supervision authority.
- Personnel engaged in on-site commissioning must be proficient in first aid for electric shock.
- Personnel engaged in on-site commissioning must remain focused on the task at hand. Do not touch any cables unless they have been confirmed to be voltage-free using a multimeter.
- Before starting the commissioning process, personnel must carefully check that the tools are safe and reliable, and wear necessary PPE to prevent accidents during work.

### ESS Inspection

- Check that the connections of the positive and negative cables of the Rack, as well as the cables of the DC/AC power converter unit, BSP, and Rack fuse, are correct.
- Check that the cables of the Rack, DC/AC power converter unit, BSP, and Rack fuse are securely connected.
- Check that the communication cables of the Rack, DC/AC power converter unit, BSP, and liquid cooling unit are reliably connected.
- Check that the Rack, DC/AC power converter unit, BSP, and liquid cooling unit are reliably grounded.
- Check that the Packs and liquid cooling pipes are free from any coolant leakage.
- Check that the load switch on the BSP is in the open state.

## 3.2 Power-on Procedure

Inspect the equipment thoroughly before powering it on. The equipment can only be powered on after all the inspection items are confirmed to meet the requirements.

**NOTICE**

**Before the ESS is powered on for the first time, disconnect the red actuation cable of the aerosol fire extinguishing equipment to prevent accidental activation. The disconnection point is inside the junction box of its accessories. Reconnect the actuation cable once the FSS enters normal operation.**

- The power and communication wiring of the ESS have been completed.
- The outdoor temperature is in the range of -30°C to 50°C.



It is not recommended to power on the equipment at temperatures below -30°C. If the temperature is too low, it will take 24 consecutive hours or more for the system to heat the cells. During this period, the system cannot operate normally.

- Step 1** Turn on QF1 (AC main switch) on the BSP to power the AC side of the system.
- Step 2** Turn on Q1 (AC auxiliary switch) on the BSP to power the auxiliary power supply.
- Step 3** Turn on Q2 (UPS switch) on the BSP. The system's auxiliary power supply will start working (devices including the switch, LC, and fans are all powered on).
- Step 4** Press and hold the UPS power button to turn on UPS power. At this time, the auxiliary power supply is completed.
- Step 5** Start up the system via the control software.



**Figure 3-1** Power-on Procedure

\*The figure is for reference only. The actual product may differ.

--End

**WARNING**

**If a circuit breaker trips during the power-on process, do not close any other circuit breakers. Immediately check for a short circuit in the downstream loads of the tripped circuit breaker.**



- The auxiliary power supply is used to power devices including the switch, LC, and fans.
- The liquid cooling unit may be switched on at factory. Check whether it is switched on when powering on.

### 3.3 Preparation Before Operation

- After powering on, check and resolve any faults displayed by the system.
- Verify that the software version is correct.
- Access the Web user interface of the LC and confirm that the parameter configuration file is correct. Do not modify the configuration parameters.
- If the system has been powered off and stored in a low-temperature environment for an extended period, and the cell temperature is below the charging and discharging startup requirements, the ESS cannot be started up directly. Before startup, connect the auxiliary power and activate the liquid cooling unit to preheat the cells. The preheating time depends on the initial temperature of the cells. In extreme low-temperature conditions (e.g., when the cell temperature is  $-30^{\circ}\text{C}$ ), it may be necessary to activate the liquid cooling unit up to two days in advance to preheat the cells.

### 3.4 Commissioning

#### 3.4.1 Communication Commissioning

**Step 1** Reassign the addresses of each sub-device according to the on-site address assignment requirements.



It is recommended to configure the IP address for the connection between the LC and the EMS according to customer requirements. Other sub-devices can retain their default IP addresses without any changes.

**Step 2** Use the background monitoring system (EMS) to read the data from the LC and all sub-devices. Verify that data reading is successful.

**Step 3** Use the background monitoring system (EMS) to send system shutdown and startup commands and charging/discharging power commands. Verify that the functions are working properly.

**Step 4** Use the background monitoring system (EMS) to change the control parameter settings. Verify that the functions are working properly.

--End

### 3.4.2 Startup/Shutdown Commissioning

#### Prerequisite

**i** This section uses the user interface of the standard configuration as an example. The actual user interface may vary.

#### Preparation Before Login

- Set the IP address of the PC to be on the same network segment as that of the device.
- Connect the PC to the ETH2 port of the device.



**Figure 3-2** ETH2 Port

\*The figure is for reference only.

- The default IP address of the ETH2 port is 192.168.0.100. The IP address of the PC can be set to 192.168.0.99 and the subnet mask to 255.255.255.0.

**Step 1** Log in to the Web user interface of the LC.

- Connect the PC to the device with an Ethernet cable.
- In the PC address bar, enter the IP address of the LC, such as 192.168.0.100, to go to the login page, as shown in the following figure.



**i** The IP address is subject to actual project configuration.

- c. Enter the username and password. Click **Login**.



The system supports two user roles: **Operator** and **Admin**.  
Contact SUNGROW for the password.

- d. In the upper right corner of the page, select your preferred language.

**Step 2** Click startup on the home page. Check whether the power, voltage, current, and temperature of the sub-devices are normal.

**Step 3** Choose **Parameter settings > Running parameters > Mode settings**, and gradually increase the power until full-power operation is reached.

- a. Set the discharging power to 10 kW.



- b. Choose **Running information > PCS information** to check the current system power of the DC/AC power converter unit.



**Step 4** Repeat Step 3. Set the grid-connected power to 50 kW, 125 kW, -10 kW, -50 kW, and -125 kW, and verify that the power of the DC/AC power converter unit matches the set values.

**Step 5** If no alarms or faults occur during commissioning, the commissioning is considered successful. You can then use the LC to shut down the system.

--End

### 3.4.3 Charge-Discharge Cycle Test

- Step 1** The background monitoring system performs a full charge-discharge cycle based on the actual charging and discharging capability of the Rack to calibrate the battery SOC and ensure SOC balance.
- Step 2** During the charging-discharging process, verify that the voltages, currents, and temperatures of the Rack and individual cells remain within normal ranges.
- Step 3** Check that the voltage, current, and temperature data of the DC/AC power converter unit remain within normal ranges.
- Step 4** Check whether the cell voltage difference, temperature difference, and Rack SOC show significant deviations.
- End**

## 4 Routine Maintenance

### 4.1 Precautions Before Maintenance

#### WARNING

- During daily operation, the doors of the ESS and its internal devices must all be closed and locked. Besides, the keys should be pulled out and handed over to the designated personnel for safekeeping. This prevents accidents caused by unauthorized entries and protects the internal devices against rain water or damages by animals.
- Do not open the door and maintain the ESS on rainy, humid, or windy days. SUNGROW shall not be held liable for any possible damage arising from failure to observe this instruction.
- Do not open the cabinet door on days with rain, snow, heavy fog, or high humidity. Make sure the sealing strip around the door does not curl after closing the cabinet door.
- Do not open the cabinet door on sandy, windy, rainy, or snowy days or when the relative humidity in the surrounding environment is greater than 95%.

#### WARNING

- Fans such as cooling fans inside the ESS may produce noise during operation, and the noise may get louder in case of a fault. It is suggested to wear earplugs before entering the plant.

**⚠ WARNING****Warning for voltages:**

- **Hazardous voltages inside! Accidentally touching may lead to fatal electric shocks.**
- **When the ESS or the external control circuit is powered, do not perform any operation on the control cables. Even if the power supply to the ESS has been disconnected, the externally-powered control circuit may still generate hazardous voltages inside the ESS.**
- **If only the DC switch is turned off, the wiring terminals inside the ESS will still carry voltage.**
- **To avoid electric shock, do not perform any other maintenance operations beyond this manual.**
- **If necessary, contact SUNGROW Customer Service for maintenance.**

**⚠ WARNING****Requirements for inspection after power-off:**

- **Put up highly visible warning signages near the switches that have been switched off, to prevent accidental switching-on.**
- **Do not turn off any AC or DC side switch directly during normal equipment operation. Otherwise, it may result in electrical arcs and damage the switches or even the ESS.**
- **Disconnect all external connections to the ESS and connections to the internal power supply.**
- **Ensure the points of disconnection will not be reconnected to power by accident.**
- **Test using a multimeter and ensure the parts to be maintained inside the cabinet are completely voltage-free.**
- **Make necessary grounding and short-circuit connections.**
- **For the potentially live parts near the area of operation, cover them with insulated cloth for shielding.**
- **Wait at least 20 minutes after the ESS is powered off, and then open the cabinet door.**
- **Some devices in the ESS may contain heat-generating components that remain in high temperature after the devices stop operating. Wear burn-proof gloves or other protective equipment when working on such components.**

**NOTICE**

**Remove accumulated snow promptly from the cabinet and peripheral areas during heavy snowfall at project sites.**



Under clear weather conditions, it is recommended to open the cabinet doors to ventilate and dehumidify the equipment.

## 4.2 Cabinet Maintenance

### 4.2.1 Repair Exterior Damage



Inspect the product enclosure for paint peeling annually. If any damage is found, repair it promptly. Spray the exterior of the whole product with specialized protective paint every five years.

#### Repair Solutions

Check the exterior damage and choose an appropriate solution based on the severity of the damage.

Severity	Repair Solutions
Removable surface dirt and stains	<a href="#">4.2.1.1 Clean Removable Dirt</a>
Finish coat peeling and primer intact	<a href="#">4.2.1.2 Repair Finish Coat</a>
Primer damaged and substrate exposed	<a href="#">4.2.1.3 Repair Primer and Finish Coat</a>

#### 4.2.1.1 Clean Removable Dirt

##### Prerequisite

For dust or dirt on the product enclosure, clean it with water or alcohol as needed.

##### Tools to be Prepared by Users

**Table 4-1** Tools and Materials

No.	Item
1	Cleaning cloth
2	Water
3	Alcohol or other non-corrosive cleaning agents

**Step 1** Wet the cloth (or other scrubbing tools) with water, then wipe the dirty areas on the surface.

**Step 2** If water cannot remove the dirt, use 97% alcohol to wipe the surface until it is clean enough (You may also use non-corrosive cleaning agents that are commonly used in your area.)



--End

#### 4.2.1.2 Repair Finish Coat

##### Prerequisite

If minor scratches or finish coat powdering result in the paint peeling off without exposing the substrate, repair the finish coat.

##### Selection and Formulation of Finish Coat

**Table 4-2** Selection and Formulation of Finish Coat

Brand and Model	Chemistry	Mix Ratio	Thinner	Drying Time (Minimum)
Jotun finish coat Hardtop XP or Hardtop XPL	Two-component chemically-curing aliphatic paint	Ratio of base agent to curing agent: 10:1 (by volume)	Jotun Thinner No. 10	5°C, 24 h 10°C, 12 h 23°C, 5 h 40°C, 3 h
AkzoNobe I finish coat Interthane 990	Two-component acrylic urethane paint	Ratio of base agent to curing agent: 6:1 (by volume)	International GTA056	5°C, 24 h 25°C, 6 h 35°C, 4 h



- If using paints from other manufacturers, please contact SUNGROW for confirmation.
- For two-component paint supplied in two parts, each part must be agitated thoroughly before being mixed in the specified proportions.
- The thinner can be added only after the base and curing agent have been mixed.
- Do not use paint past its shelf life.

### Tools to be Prepared by Users

**Table 4-3** Tools

No.	Item
1	400-grit / 600-grit sandpaper
2	Cleaning cloth
3	Alcohol
4	Brush
5	Finish coat
6	Coating thickness gauge

### Environment Requirements

- Ambient temperature: 5°C–40°C
- Substrate temperature: 5°C–60°C
- Relative humidity: 10%–85% RH

### Procedure

- Step 1** Use sandpaper to grind the area with burrs or scratches until the gray primer is exposed. Measure the primer thickness using a coating thickness gauge. The primer shall be at least 150 µm thick.
- Step 2** Remove all residues from the surface using a clean brush.
- Step 3** Wipe the surface with a clean cloth dampened with alcohol or a cleaning agent to remove any remaining powder or dust. Ensure the surface is clean.



**Step 4** Repair the finish coat.

- a. Check the surface color and prepare the finish coat in the matching color.

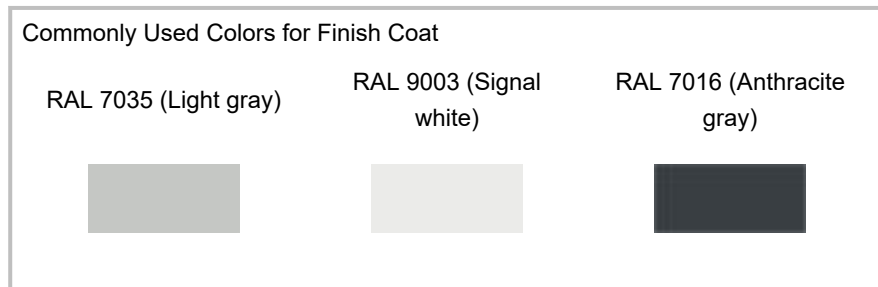

- b. Prepare the finish coat paint according to the specifications provided in [Table 4-2 Selection and Formulation of Finish Coat](#).
- c. Apply the paint in a criss-cross pattern. Once the coat is fully dried, measure the coat thickness with a coating thickness gauge. The thickness for a single layer shall be within the range of 50–100  $\mu\text{m}$ .



- d. When applying multiple coats, make sure the previous coat has completely dried before applying the next. The final total thickness, including both the primer and finish coat, shall be at least 240  $\mu\text{m}$ .

**Step 5** Inspect the coating appearance to ensure uniform color, smooth transitions, and compliance with the specified thickness.

--End

### 4.2.1.3 Repair Primer and Finish Coat

#### Prerequisite

If the rusted area is large, with deep scratches and dents exposing the substrate, both the finish coat and primer need to be repaired.

#### Selection and Formulation of Primer and Finish Coat

**Table 4-4** Selection and Formulation of Primer and Finish Coat

Brand and Model	Chemistry	Mix Ratio	Thinner	Drying Time (Minimum)
Jotun primer Jotamastic 90	Two-component epoxy paint	Ratio of base agent to curing agent: 3.5:1 (by volume)	Jotun Thinner No. 17	5°C, 30 h 10°C, 10 h 23°C, 3 h 40°C, 1.5 h
AkzoNobel primer Interseal 670HS	Two-component epoxy paint	Ratio of base agent to curing agent: 5.67:1 (by volume)	International GTA220	5°C, 36 h 10°C, 16 h 25°C, 10 h 40°C, 4 h
Jotun finish coat Hardtop XP or Hardtop XPL	Two-component chemically-curing aliphatic paint	Ratio of base agent to curing agent: 10:1 (by volume)	Jotun Thinner No. 10	5°C, 24 h 10°C, 12 h 23°C, 5 h 40°C, 3 h
AkzoNobel finish coat Interthane 990	Two-component acrylic urethane paint	Ratio of base agent to curing agent: 6:1 (by volume)	International GTA056	5°C, 24 h 25°C, 6 h 35°C, 4 h



- It is recommended to use primer and finish coat from the same manufacturer.
- If using paints from other manufacturers, please contact SUNGROW for confirmation.



- For two-component paint supplied in two parts, each part must be agitated thoroughly before being mixed in the specified proportions.
- The thinner can be added only after the base and curing agent have been mixed.
- Do not use paint past its shelf life.

### Tools to be Prepared by Users

**Table 4-5** Tools

No.	Item
1	400-grit / 600-grit sandpaper
2	Cleaning cloth
3	Alcohol
4	Brushes of different sizes
5	Grinder (with conical and cylindrical grinding heads)
6	Putty
7	Finish coat
8	Primer
9	Coating thickness gauge

### Environment Requirements

- Ambient temperature: 5°C–40°C
- Substrate temperature: 5°C–60°C
- Relative humidity: 10%–85% RH

### Procedure

**Step 1** Grind all uneven areas of the coating with a grinder or sandpaper until the surface is smooth and shows a metallic luster, with a seamless transition between the rusted area and the intact coating.



Uneven areas include residual burrs, metal fragments, and welding slag on the mechanical structure, as well as seams and sharp edges.

**Step 2** For major defects such as scratches or bumps, apply putty to the target area to create a smooth and even surface.

**Step 3** Remove all residues from the surface using a clean brush.

**Step 4** Wipe the surface with an alcohol-dampened cloth to remove any remaining dust and debris.



**Step 5** Repair the primer.

- a. Check the surface color and prepare the primer in the matching color.

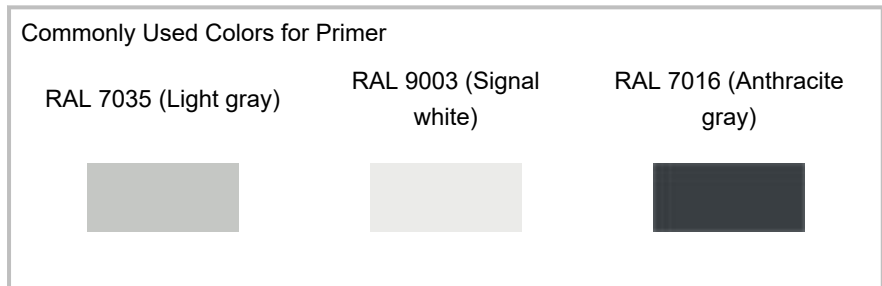

- b. Prepare primer according to the specifications provided in [Table 4-4 Selection and Formulation of Primer and Finish Coat](#).
- c. Apply the primer with a small brush as a pre-coat. Measure the coating thickness at corners and seams using a coating thickness gauge, and verify that the thickness is between 70  $\mu\text{m}$  and 80  $\mu\text{m}$ .
- d. After the pre-coat has dried, apply the primer in a criss-cross pattern. After drying, verify that the dry film thickness is within the range of 100–300  $\mu\text{m}$ .

**Step 6** To repair the finish coat, see [4.2.1.2 Repair Finish Coat](#).

**Step 7** Inspect the coating appearance to ensure uniform color, smooth transitions, and compliance with the specified thickness.

--End

For spray-type paint:



1. Cover the area within an 800 mm radius around the damaged spot using masking paper.
2. Spray paint the exposed area. After drying, verify that the dry film thickness is within 100–300 µm.

## 4.2.2 Inspect Door Locks and Hinges

After cleaning, check that the door locks and hinges of the ESS can function properly. Lubricate the door lock holes and hinges if necessary.

## 4.2.3 Inspect Sealing Strips

Intact sealing strips effectively prevent water ingress into the cabinet. Inspect the strips carefully and replace any damaged ones.

# 4.3 Battery Maintenance

## 4.3.1 Maintenance Precautions

### WARNING

Do not allow the product to remain in a low voltage or low SOC condition for a long time. Capacity loss resulting from any of the following conditions is not covered by warranty:

- The discharging cell voltage remains below 2.7 V for 120 consecutive hours.
- The SOC of any Rack remains at 0% for 120 consecutive hours.
- The discharging cell voltage is below 2 V.

### WARNING

Cell overvoltage and undervoltage faults/alarms (For details, see Communication Protocol > LC300 Info-3x table > CMU fault word/CMU alarm word).

- **Faults:** “Cell overvoltage fault”, “Cell undervoltage fault”, “Total voltage overvoltage fault”, “Total voltage undervoltage fault”.
- **Alarms:** “Cell overvoltage alarm”, “Cell undervoltage alarm”, “Total voltage overvoltage alarm”, “Total voltage undervoltage alarm”.

End users must prioritize resolving the above faults and alarms reported by the SUNGROW local controller. The relevant fault or alarm information will be shown on the user interface. In addition, users shall contact SUNGROW to resolve the problems promptly to prevent the battery from overdischarging or overcharging, which may void the warranty.

**NOTICE**

- **To avoid voiding the warranty, if a cell undervoltage or overvoltage fault occurs, users must contact SUNGROW's local team within 24 hours and follow their instructions.**
- **The active recharge function is enabled by default at the factory (if the system supports this function). If the SOC is too low, the system will automatically charge the batteries at a low current, until the SOC reaches the safe threshold (configurable). SUNGROW recommends keeping this function enabled to minimize the risk of voiding the warranty due to battery undervoltage.**

**NOTICE**

- **If the system remains inactive for 7 days or longer, it is suggested to raise the SOC lower limit protection value to above 10%. Besides, regularly monitor the system SOC to prevent overdischarge, which may void the warranty.**
- **During maintenance or shutdown, if the SOC of any Rack falls to 0%, charge it to at least 15% within 120 hours.**
- **During operation, if the SOC of any Rack falls to 0%, charge it to at least 5% within 2 hours. Alternatively, when the SOC reaches 0%, switch the system to recharging mode via the upper computer EMS.**
- **If the system is stored for six months or longer, before putting it into operation for the first time, complete at least one full charge to activate the batteries.**

SOC calibration is required under the following conditions during battery system operation:

- If the SOC does not reach 1%–5% during discharging and 97%–100% during charging, it is recommended to perform calibration once a month.
- If the battery system discharges to 1%–5% SOC or charges to 97%–100% SOC, and the resting time is less than 2 hours, it is recommended to perform calibration once a month.



During operation, if the battery system discharges to 1%–5% SOC or charges to 97%–100% SOC, and the resting time is equal to or greater than 2 hours, no additional calibration is required.

- Calibration is recommended when there is a major change in operating conditions, such as switching from capacity market to frequency regulation.

**Manual SOC Calibration**

1. Set the SOC protection lower limit to 1%–5% and upper limit to 97%–100%.
2. Discharge the system until the SOC reaches the lower limit, and then let the system rest for 2 hours without changing the power command.
3. Charge the system until the SOC reaches the upper limit, and then let the system rest for 2 hours without changing the power command.
4. The SOC calibration is completed and the system can be put back into operation.

For safe and effective maintenance of the system, maintenance personnel must carefully read and observe the following safety requirements.

1. Maintenance personnel must hold an electrician's license issued by the local safety supervision authority and successfully complete professional training before operation.
2. Observe related safety precautions, use dedicated tools, and wear PPE.
3. Do not wear jewelry or metal accessories such as watches.
4. Do not touch the positive and negative HV terminals of the ESS at the same time.
5. Turn off all HV and LV switches before maintaining the ESS.
6. Do not clean the ESS with water directly. Use a vacuum cleaner if necessary.
7. Connect and disconnect cables by following the standard operation procedure. Do not connect or disconnect any cables brutally.
8. Put away the tools and materials in time after maintenance. Check that no metal objects are left inside or on top of the equipment.
9. If there is any question about the operation and maintenance of the equipment, please contact SUNGROW Customer Service. Unauthorized operation is prohibited.

#### 4.3.2 Device Maintenance

1. Recommended ambient temperature during Pack operation:  $-30^{\circ}\text{C}$  to  $50^{\circ}\text{C}$ . During charging and discharging, the temperature should ideally be maintained between  $15^{\circ}\text{C}$  and  $30^{\circ}\text{C}$ ; the typical value is  $25^{\circ}\text{C}$ .
2. Do not charge or discharge the Rack at a high rate. The continuous charging and discharging current of each Rack should be below its rated current.
3. If the ESS is left unused for a long time, perform charging and discharging once every six months until the system SOC reaches 30%–40%. Make sure the SOC values are consistent after recharging.
4. Before putting a long-idle system into operation, perform at least one full charge to restore optimal battery performance.
5. When maintaining the top-layer Pack, remove adjacent smoke detectors, heat detectors, and any other components that could obstruct Pack removal. Ensure no devices are damaged during the removal process.
6. Regularly inspect the air ducts of the heat dissipation system for blockage. Clean the system regularly, especially the air inlets and outlets of the fans (use a vacuum cleaner if necessary), to ensure proper air circulation within the cabinet. Be sure to disconnect the power supply before cleaning, and never use water directly on the system.
7. Regularly inspect the HV cables and connection bars of the ESS for loose bolts or poor contact, and inspect terminals for rust or oxidation.
8. Regularly inspect the positive and negative HV protective covers of the Pack for aging, damage, or absence.
9. Regularly inspect the cables for loose connections, aging, or damage, and check that the cables are well insulated.
10. Regularly check for any pungent smell inside the cabinet and any burnt smell around HV connections.

- 11. Regularly verify on the monitoring upper computer that parameters like voltage and temperature are normal, and check for any active alarms.
- 12. Regularly inspect the status and alarm indicators on the ESS to ensure they are physically intact and functioning correctly.
- 13. Regularly check that the emergency stop button of the ESS can function properly. Ensure the system can be rapidly shut down in case of an emergency.
- 14. Regularly verify that the FSS is operational and that all equipment is within its valid service period.
- 15. Do not connect Packs of different types in series or parallel.
- 16. Packs of different models (Pack A and Pack B within the system) must not be interchanged.

**⚠ WARNING**

- **The battery is potentially hazardous. Take proper precautions when operating and maintaining the battery.**
- **Improper operation may result in serious personal injury and property damage!**
- **Operate the battery using proper tools while wearing proper PPE.**
- **The battery can only be maintained by personnel with battery expertise and safety training experience.**

### 4.4 Liquid Cooling System Maintenance

The recommended maintenance items are listed in the table below. Actual maintenance activities shall be adjusted according to the overall installation environment.

The maintenance frequency is subject to factors like plant size, installation position, and on-site environment. For the equipment operating in sandy or dusty environments, it is necessary to increase the frequency of maintenance.

Item	Inspection Details	Inspection Method	Tools
Fan	Check whether the blades rotate properly and are free from damage. If the blades fail to operate properly or are damaged, replace the fan.	1. The fan blades rotate smoothly without unusual noise. 2. The fan blades have no damage. Note: Inspection shall be carried out at least every six months. Optional for damage inspection.	Screwdriver with long handle
Pump	1. Check whether an area of over 5% of the air inlet hole	1. The pump operates smoothly without	Brush

Item	Inspection Details	Inspection Method	Tools
	of the pump is blocked. If so, remove the blockage with a brush. 2. Inspect the pump body (not the pipe joints) visually, and see if there is visible dripping (except condensation). If so, replace the sealing ring of the pump.	abnormal noise. 2. There is no visible dripping on the pump body (except condensation).	
Coolant circulation system	Check whether the liquid cooling unit reports an alarm via the HMI.	If the liquid cooling unit reports a low coolant level alarm, refill the coolant tank.	Slotted screwdriver, Phillips screwdriver, pump, hoses, clamps

# 5 Common Maintenance Operations

## 5.1 Safety Precautions

### WARNING

- Do not connect or disconnect any power cable when the equipment carries voltage. Turn off the power supply before connecting or disconnecting any power cable.
- Proceed with maintenance only after the power is off. Do not restore power during operation. If an operation requires power to remain on (e.g., running the liquid cooling unit), ensure that all wiring is properly completed before connecting the power.
- Voltage may be generated on the battery or grid side. Verify that there is no voltage present using a standard voltmeter before touching.
- Voltage may remain in the batteries even after the DC power supply of the ESS is disconnected. Before performing any operation, wait 5 minutes and then verify that the equipment is completely de-energized.

### WARNING

- Wear PPE when performing equipment maintenance or servicing. Maintenance personnel must wear safety goggles, helmets, insulated shoes, and gloves.
- Put up highly visible warning signs around the equipment to prevent accidents caused by inadvertent switching-on. Set up warning signages or fence off a warning zone near the equipment.

### WARNING

- The coolant is toxic. Avoid ingestion and prolonged skin contact. In case of accidental eye contact, rinse immediately with clean water and seek medical attention promptly.
- The coolant and its packaging must not be discarded randomly. The disposal must comply with applicable local regulations.
- When replacing the coolant (ethylene glycol solution) or performing maintenance on liquid cooling pipes, wear PPE such as goggles.

**NOTICE**

- Operators must have certain electrical wiring, electronic, and mechanical expertise, and be familiar with electrical and mechanical schematics. Operators must be familiar with the composition and working principles of the ESS and its upstream and downstream equipment.
- Operators must have received professional training in the installation and commissioning of electrical equipment.
- Operators must be able to respond quickly and effectively to dangers or emergencies that may occur during the process of installation and commissioning.
- Operators must be familiar with applicable local standards and specifications of the country/region where the project is located.

**NOTICE**

- Hoisting, transportation, installation, wiring, and operation and maintenance must all be carried out in compliance with the relevant laws and regulations in the place where the project is located.
- Follow the procedure for working at heights when walking on the top of the equipment.

## 5.2 Coolant Draining and Refilling

### 5.2.1 Overview of Liquid Cooling System

#### Liquid Cooling Unit Compartment

The liquid cooling unit compartment is shown in the figure below.



**Figure 5-1** Liquid Cooling Unit Control Panel

\*The figure is for reference only.

**BSP**

The terminals used for the power supply wiring of the liquid cooling unit are located on the BSP, as shown below.



**Figure 5-2 BSP**

\*The figure is for reference only.

**5.2.2 Coolant Replacement Interval**

**Prerequisite**

Item	Conditions Requiring Coolant Replacement	Replacement Interval	Tools
Coolant	1. The coolant contains visible impurities. 2. The coolant color has significantly darkened. 3. The coolant pH value is below 7.3.	5–6 years	Pump, hose, hose clamp, slotted screwdriver Note: Please contact SUNGROW for replacement.

**Coolant pH Test Procedure**

- Step 1** Shut down the system by sending a shutdown command via the LC.
- Step 2** Turn off the upstream AC power supply switch. Use a multimeter to verify that the terminals of the AC main circuit (L1, L2, L3) on the BSP are voltage-free.
- Step 3** Turn off the AC main switch, AC auxiliary switch, and UPS switch on the BSP.
- Step 4** Press and hold the UPS power button for 3 s to power off the UPS.
- Step 5** Turn off the switch on the panel of the liquid cooling unit.

**Step 6** Remove the plug from the fill port.

**Step 7** Slightly open the valve (do not fully open it) and discharge approximately 10 ml of coolant.



**Step 8** Use pH test strips or a pH meter to measure the pH of the coolant sample. If the pH is below 7.3, replace the coolant (drain and refill the system).

--End

### 5.2.3 Safety Precautions

#### **⚠ WARNING**

**Under normal conditions, coolant does not pose a health hazard, but excessive exposure may cause irritation to the eyes, skin, and respiratory system.**

#### **Personal Protective Equipment (PPE)**

Wear PPE that complies with relevant national standards during the coolant refilling process. Equipment required includes but is not limited to those listed below.

<b>Parts of Body to be Protected</b>	<b>PPE</b>
Respiratory system	Under normal conditions, respiratory protection is generally not required. If engineering control equipment cannot maintain airborne concentrations at a level safe for human, select suitable respiratory protective equipment that complies with applicable legal requirements. If using a safety filter mask, choose the appropriate mask and filter combination suitable for particulate matter/organic gases and vapors (boiling point > 65°C).
Hands	Wear oil-resistant and chemical-resistant safety gloves.

Parts of Body to be Protected	PPE
Eyes	Wear safety goggles.
Skin and body	Wear impermeable protective clothing and safety shoes.

**Waste Disposal**

Waste Type	Disposal Method
Coolant	Dispose of coolant according to local regulations. Do not release indiscriminately.
Residual waste	Sort and recycle. Items may be incinerated or reused if compliant with applicable regulations.
Container	Consult applicable national and local regulations before disposal. Recycling or reuse is preferred. If these options are not feasible, incineration is recommended for empty containers that may contain harmful residues. Do not cut, puncture, or weld on or near the container. Labels on the container may only be removed after thorough cleaning. Contaminated containers must not be treated as household waste. Containers shall be properly cleaned or disposed of by landfill or incineration. Do not incinerate sealed containers.

**Emergency Response to Leaks**

In the event of a coolant leak, take the following measures:

- Immediately contact qualified personnel and evacuate all non-essential personnel to a safe area.
- Stop the source of the leak if possible. Prevent the leaked coolant from entering sewers, drains, or bodies of water.
- Wear appropriate PPE when handling the leak to avoid contact with the spilled or released substance.
- Contain the leaked coolant with sand, earth, or other suitable barriers to prevent further spread. Recover the coolant directly or collect it in absorbent materials. Clean the contaminated area with detergent, water, and a stiff broom, and place the collected coolant into a disposable container.

**First Aid Measures**

Route of Exposure	First Aid Measures
Inhalation	Move away from the contaminated area to fresh air immediately and ensure the airway is clear. If one has difficulty

Route of Exposure	First Aid Measures
	breathing, administer oxygen; if one stops breathing, begin artificial respiration immediately and seek medical attention.
Skin contact	Remove any contaminated clothing immediately. Rinse your skin thoroughly with plenty of running water, and seek medical attention.
Eye contact	Rinse your eyes with clean running water or physiological saline for at least 15 minutes. Seek medical evaluation promptly.
Ingestion	If one has ingested coolant and is conscious, drink water or milk, and seek medical attention immediately. Do not induce vomiting unless instructed by a physician. If assistance from a physician is not available, take the patient, the container, and the label to the nearest medical emergency center or hospital. Do not give any food or drink to an unconscious person.

### 5.2.4 Overview of Maintenance Tooling

The coolant fill and drain tool consists of a handle, a pressure gauge, a drain valve, a pump switch, a power indicator, a pump operation status indicator, a power cord cabinet, and a hose cabinet.

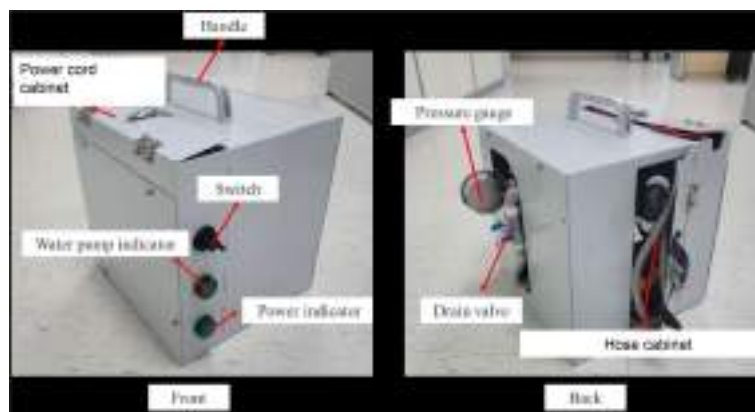

**Figure 5-3** Coolant Fill and Drain Tool

A 5-meter power cord (longer than the distance between the BSP and the main pipe's coolant fill port) is stored in the power cord cabinet, while fill and extraction hoses are kept in the hose cabinet. The fill hose features a quick-connect fitting that matches the main pipe's coolant fill port and a ball valve (V5). The dedicated drain hose for the piping can also be stored in the hose cabinet.

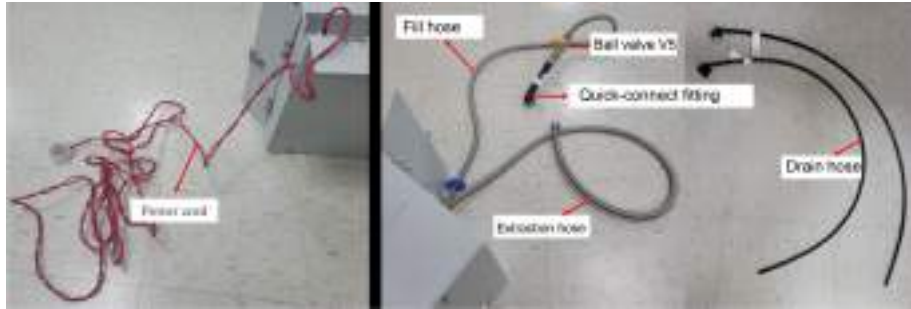

**Figure 5-4** Power Cord and Hoses

The technical data of the coolant fill and drain tool is shown as follows:

**Table 5-1** Technical Data of Coolant Fill and Drain Tool

No.	Parameter	Value
1	Dimensions	270 mm * 300 mm * 300 mm
2	Weight	≤ 10 kg
3	Rated voltage	24 V DC
4	Load current	≤ 4 A
5	Power	≤ 96 W
6	Flow rate	12 L/min
7	Head	2.5 Bar
8	Other functions	Non-return design. Non-return design. The matching drain hose can also be stored in the hose cabinet.

### 5.2.5 Drain Coolant

- Step 1** Verify that both the system's auxiliary power supply and the liquid cooling unit's power supply are switched on.
- Step 2** Remove the plug from the system's drain port.
- Step 3** Put the coolant barrel in place. Take out the extraction hose from the hose cabinet of the coolant fill and drain tool and put it into the barrel.

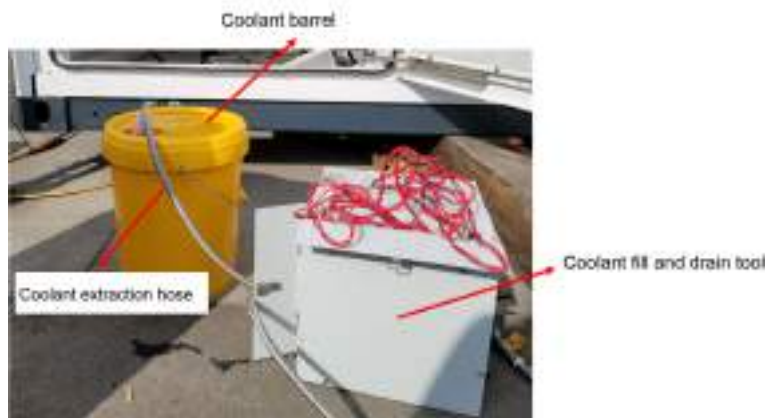

- Step 4** Open the ball valve on the liquid cooling pipe of the target battery compartment.
- Step 5** Pinch both ends of the clip on the plug at the drain port, then remove the plug.
- Step 6** Retrieve the fill hose from the hose cabinet of the coolant fill and drain tool. Insert its quick-connect fitting into the system's drain port, and push the locking clip in place to secure the fitting.
- Step 7** Open the V5 ball valve on the fill hose of the tool.

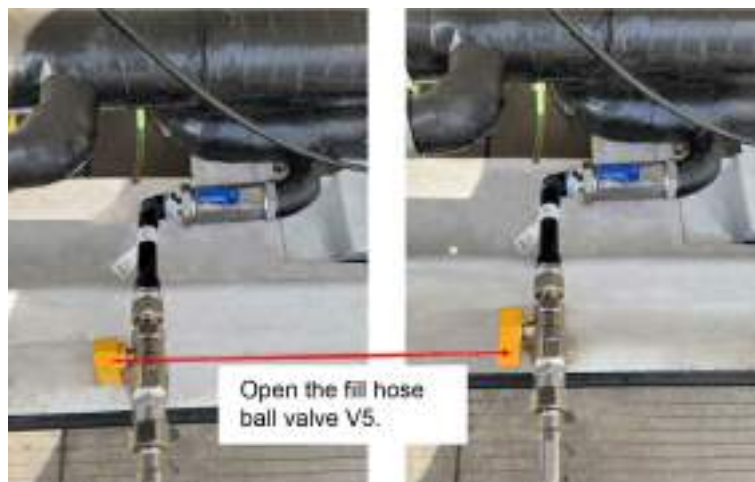

- Step 8** Open the drain valve of the fill and drain tool. Observe that coolant begins to flow out.

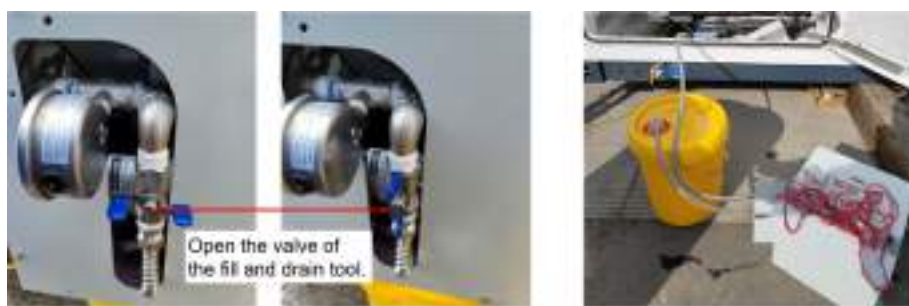

Overall Layout

**Step 9** If no liquid flows out of the extraction hose for 30 s, the coolant in the system has been fully drained. Remove the extraction hose, install the plug, and secure the clip.

**Step 10** After pipe maintenance is complete, proceed with coolant refilling.

--End

### 5.2.6 Refill Coolant

**Step 1** Check that the ball valves V1 and V2 on the expansion tank of the liquid cooling unit are open.

**Step 2** Check that the ball valves V3 and V4 on the Rack are fully open.

**Step 3** Open the exhaust valve. A loose knob indicates that the exhaust valve is open.

**Step 4** Check the drain port D1 and make sure it is plugged.

**Step 5** Prepare one barrel of coolant. Take out the extraction hose from the hose cabinet of the coolant fill and drain tool, then put it into the barrel.

**Step 6** Retrieve the fill hose from the hose cabinet, insert the quick-connect fitting of the hose into the liquid cooling unit's fill port, and push the locking clip in place to secure the fitting.

**Step 7** Open the valve at the fill port of the liquid cooling unit, as well as the ball valve V5 of the fill hose of the coolant fill and drain tool.

**Step 8** Close the drain valve of the coolant fill and drain tool.



**Step 9** Connect the power supply cable of the coolant fill and drain tool to the BSP. Once power is connected, observe that the power indicator of the tool turns on.

**Step 10** Turn on the circuit breaker of the liquid cooling unit. Observe that the power indicator of the liquid cooling unit turns on.

**Step 11** The liquid cooling unit will start up with a delay after it is powered on. Shut down the unit via the LC user interface.

**Step 12** Set the liquid cooling unit to high-speed mode.

- a. Choose **Parameter settings > System parameters** and go to the section Liquid cooling unit debugging parameters. Set Liquid cooling unit debug mode to Enable.
- b. Set Control mode to Pump cycle mode and Pump speed to 80%.

**Step 13** Switch on the fill and drain tool. The pump operation indicator lights up and the coolant filling begins.



- Step 14** Monitor the coolant level in the glass tube through the monitoring window. Stop filling when the coolant level reaches the upper limit (H line).
- Step 15** Close the valve at the fill port. Shut down the liquid cooling unit after it runs for 1 min (The liquid level will drop rapidly during the initial filling and the system will shut down if the level falls below the lower limit L line.)
- Step 16** Repeat Steps 13 to 15 three times. After-sales personnel should monitor the coolant level in the barrel. If the coolant is used up, switch off the tool first and then replenish the barrel.
- Step 17** Run the liquid cooling unit in high-speed mode for 20 min. If leakage is observed, drain coolant from the system, inspect or replace the pipes (do not connect or disconnect the pipes when they are pressurized), then refill the coolant. If no leakage is observed, the leakage test has passed; proceed to the next step.
- Step 18** Set the liquid cooling unit to low-speed mode.
- Choose **Parameter settings > System parameters** and go to the section Liquid cooling unit debugging parameters. Set Liquid cooling unit debug mode to Enable.
  - Set Control mode to Pump cycle mode and Pump speed to 30%.
- Step 19** Run the liquid cooling unit in low-speed mode for 60 min. Shut down the unit.
- Step 20** In the shutdown state, coolant filling is complete when the coolant level in the glass tube is between the midline and the H line, and the outlet pressure exceeds 0.4 Bar. If the level is below the midline or the outlet pressure is low, open the valve at the fill port and add coolant until the level rises between the midline and the H line.
- Step 21** Close the valve at the liquid cooling unit's fill port after coolant filling is complete. Close the V5 ball valve of the coolant fill and drain tool.
- Step 22** Restore the liquid cooling unit parameters to factory settings.
- Choose **Parameter settings > System parameters** and go to the section Liquid cooling unit debugging parameters. Set Pump speed to 68%.
  - Set Control mode to Remote mode and Liquid cooling unit debug mode to Disable.
- Step 23** Push out the clip on the quick-connect fitting of the fill hose, and pinch the fitting to remove it.



**Step 24** Disconnect the coolant fill and drain tool's power cord and remove the network cable from the computer. Put the hoses and power cord into the corresponding cabinets.



**Step 25** Clean the residual coolant inside the cabinet with a cloth.  
--End

## 5.3 Replace Pack

### 5.3.1 Tooling Introduction

#### 5.3.1.1 Liquid Cooling Maintenance Tooling

The components of the maintenance tooling are shown below.

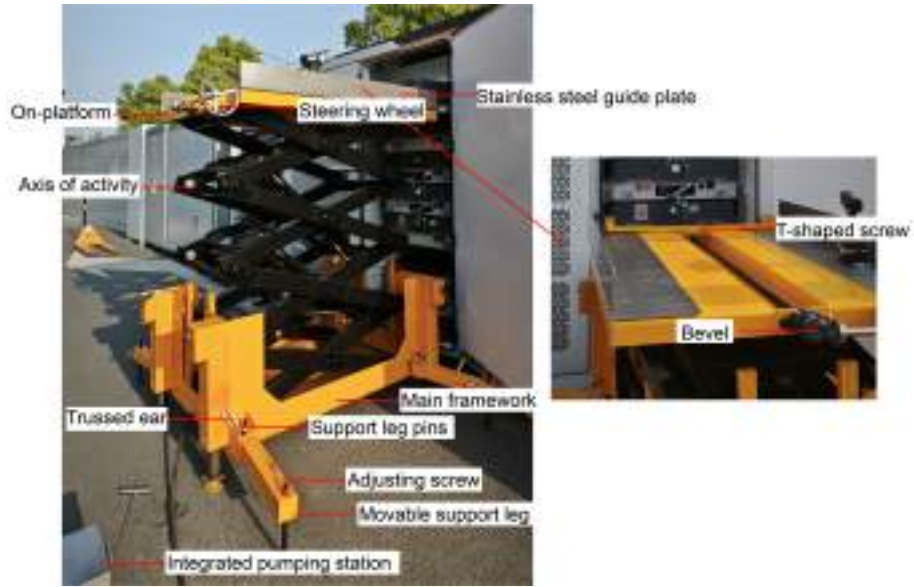

\*The figure is for reference only.

The technical data of the maintenance tooling are listed in the table below.

**Table 5-2** Technical Data of Maintenance Tooling

Item	Description	Item	Description
Code	B-J-022739	Maximum lift height	3800 mm
Load capacity	1200 kg	Extension of integrated pump hydraulic hose	800 from the equipment
Platform dimensions	1500 mm * 1035 mm	Hook opening	φ14
Transportation method	Crane	Tilt angle during lifting	≤ 5°

### 5.3.1.2 Transport Tooling

The maintenance tooling must be used in conjunction with the transport tooling. The transport tooling is shown below (code: B0J00326).



**Figure 5-5** Transport Tooling

\*The figure is for reference only.



**NOTICE**



**Do not lift the Pack above 1.5 m from the ground to prevent the risk of falling.**

**5.3.1.3 Other Tools**

It is suggested to prepare the appropriate tools, including but not limited to those listed below, to ensure the maintenance work can be completed smoothly.

Tools	Description
 <p data-bbox="292 1597 371 1626">Forklift</p>	<ul style="list-style-type: none"> <li data-bbox="735 1264 1197 1323">• A 5 t forklift that runs on oil is recommended;</li> <li data-bbox="735 1332 1197 1577">• For surfaces prone to collapse, such as soil or gravel, it is recommended to assess ground strength and use forklifts with off-road tires or lay steel plates in advance. These measures prevent the tires from sinking, thereby avoiding hindrance to the maintenance process.</li> </ul>

Tools	Description
 <p data-bbox="259 490 406 519">Safety helmet</p>	-
 <p data-bbox="259 793 399 823">Safety shoes</p>	-
 <p data-bbox="259 1087 406 1117">Safety gloves</p>	-
 <p data-bbox="259 1342 350 1372">Eye bolt</p>	<ul style="list-style-type: none"> <li>• M8 * 70 eye bolt (4 pcs).</li> <li>• Included in tooling configuration.</li> </ul>
 <p data-bbox="259 1646 385 1675">Screwdriver</p>	-

Tools	Description
 <p data-bbox="292 491 407 517">M8 socket</p>	<p data-bbox="732 354 1149 417">An electric M8 socket is recommended (torque adjustable).</p>
 <p data-bbox="292 795 379 821">Wrench</p>	<p data-bbox="732 674 1139 699">An Allen wrench set is recommended.</p>

\*The figure is for reference only.

### 5.3.2 Replace Pack

#### 5.3.2.1 Precautions

**⚠ DANGER**

High voltages! Danger of electric shock!

- Do not touch any live part!
- Before installation, make sure that the ESS and its internal components are all voltage-free.
- Do not place the product on flammables.

**⚠ WARNING**

During maintenance, do not step on the lead screw assembly of the tooling, to avoid getting it damaged.

**⚠ WARNING**

- Do not open the door and maintain the system on rainy, humid, or windy days. SUNGROW shall not be held liable for any possible damage arising from failure to observe this instruction.
- Do not open the cabinet door on days with rain, snow, heavy fog, or high humidity. Make sure the sealing strip around the door does not curl after closing the cabinet door.
- To avoid accidents, maintenance is not recommended on rainy or snowy days due to slippery surfaces and the risk of tire collapse.

**⚠ WARNING**

- Maintenance work must only be performed by qualified technicians. Please comply with the requirements in “Safety Precautions” in this manual. SUNGROW shall not be held liable for any personal injury or property damage arising from failure to follow the safety instructions.
- To ensure the safety of maintenance personnel and the smooth completion of maintenance, follow strictly the instructions provided in this manual during the whole process.

**NOTICE**

Do not ride on the tooling. After maintenance, secure the designated protective cover over the tooling.

### 5.3.2.2 Site Requirements

**NOTICE**

- The cables shall be buried below ground level in advance with a cable trench cover installed. The load capacity of the trench cover must be no less than 50 kN.
- The top surface of the trench cover must be level with the ground surface to allow for smooth movement of the forklift.
- The plant layout design must account for forklift access. The road must be solid enough to support the passage of a 50 kN forklift and allow the forklift to maneuver between any cabinets.
- The minimum clearance required for the operation of the maintenance tooling is 2.5 m.

### 5.3.2.3 Preparation

#### 5.3.2.3.1 Drain Coolant

Drain coolant from the system before replacing the Pack. For the specific instructions, see [5.2.5 Drain Coolant](#).

### 5.3.2.3.2 Power Off System

Power off the system before replacing the Pack.

#### Prerequisite

Preparation for powering off: Log in to the Web user interface of the LC and shut down the system (In case of an emergency, you can directly press the emergency stop button on the cabinet.)

**Step 1** Press the power button on the UPS to disconnect UPS power.

**Step 2** Turn off the UPS switch (Q2) on the BSP.

**Step 3** Turn off the AC auxiliary switch (Q1) on the BSP to disconnect the auxiliary power supply.

**Step 4** Turn off the AC main switch (QF1) on the BSP to disconnect the AC side of the system from power.

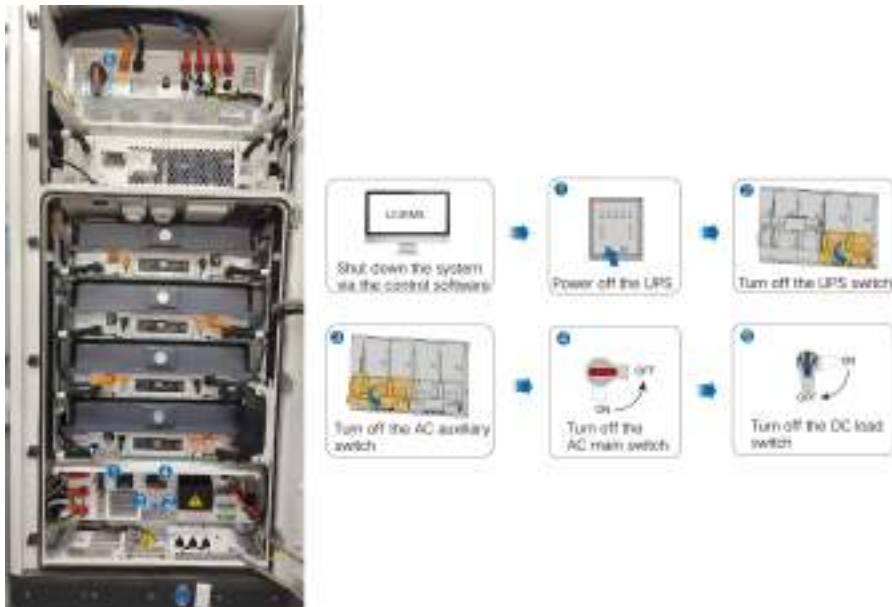

**Figure 5-6** Power-Off Procedure

\*The figure is for reference only.

--End

#### NOTICE

- **Proceed with maintenance only after the power is off. Do not restore power during operation. If an operation requires power to remain on, ensure all connections are properly completed before turning on the power.**
- **Take protective measures during the operation, such as wearing safety gloves and safety shoes.**

### 5.3.2.3.3 Open Cabinet Door

**Step 1** Open the cabinet door.

- a. Rotate the protective cover on the handle clockwise to expose the keyhole.
- b. Insert the door key and turn it clockwise.
- c. Rotate the handle anticlockwise to open the front door.

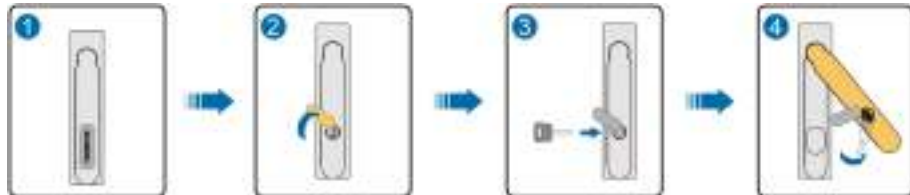

**Step 2** Open the door fully to 120°.

--End

### 5.3.2.3.4 Disconnect Liquid Cooling Pipes

**Step 1** Disconnect the liquid cooling pipes from the Pack to be replaced. Put the pipes on the inner side of the guide rail to avoid collision during Pack movement.



**Figure 5-7** Positions of Liquid Cooling Pipes

\*The figure is for reference only.

--End

### 5.3.2.3.5 Remove Cables

#### Prerequisite

The positions of the power cables and communication cables on the Packs are shown in the figure below:

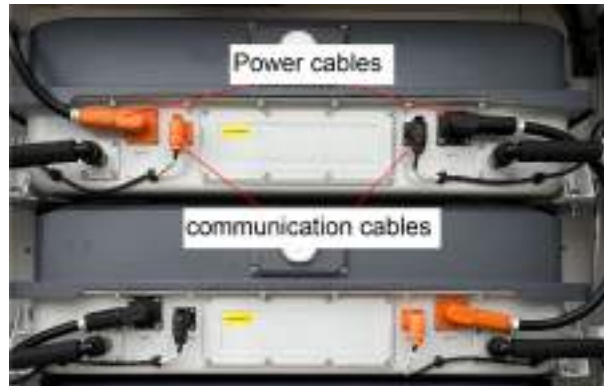

\*The figure is for reference only.

### NOTICE

**Keep the power cables and communication cables properly for later use after removing them.**

- Step 1** Press the buttons on the positive and negative connectors of the power cables, then disconnect and remove the cables.
- Step 2** Twist the positive and negative connectors of the communication cables to disconnect and remove the cables.
- End

#### 5.3.2.3.6 Remove Fuse

If the Pack to be replaced is in layer 3 or 4, remove the fuse.

#### Prerequisite

The position of the fuse is shown in the figure below.

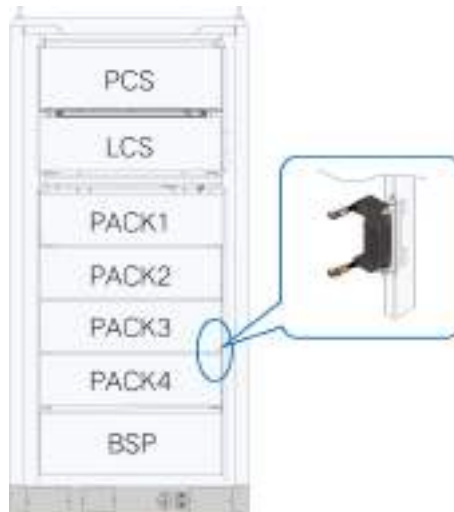

**Figure 5-8** Position of Fuse

\*The figure is for reference only.

#### **NOTICE**

**Keep the fuse properly for later use after removing it.**

**Step 1** Remove the screws from the fuse.



**Figure 5-9** Positions of Fuse Screws

**Step 2** Disconnect the cables between the fuse and the Packs, then remove the fuse.

--End

#### **5.3.2.3.7 Remove Pack Angle Brackets**

**Step 1** Remove the M8 screws from the angel brackets of the Pack using an M8 socket wrench.



**Figure 5-10** Positions of M8 Screws

\*The figure is for reference only.

**Step 2** Remove the angle brackets and keep them properly for later use.

**Step 3** Install M8 eye screws (2 pcs, included in the tooling accessories) into the screw mounting holes instead.

--End

### 5.3.3 Set Up Maintenance Tooling

#### 5.3.3.1 Initial Setup

Put the maintenance tooling in place for further adjustment and calibration.

**Step 1** Lift the platform and position it in front of the cabinet door.

Ensure a clearance of 5–10 cm between the platform and the cabinet, as shown in the figure below:

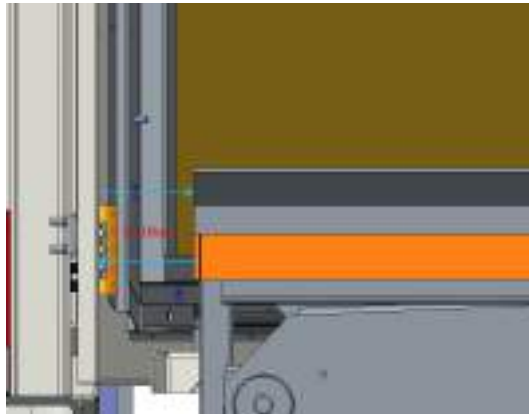

The deviation between the center lines of the platform's guide rail and the cabinet door shall not exceed 10 cm, as shown in the figure below.

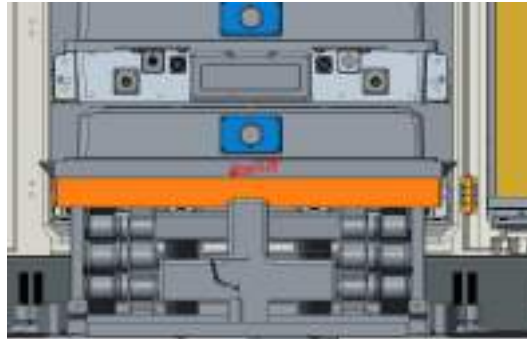

**Step 2** Unfold the platform's supports. The recommended angle is 60°–90°.

--End

### 5.3.3.2 Maintenance Tooling Adjustment

Adjust the maintenance tooling to ensure smooth Pack installation.

**Step 1** Level the platform surface (by adjusting the supports).

- a. The maintenance tooling weighs about 500 kg, and the Pack weighs about 400 kg. If the ground is not compact enough to provide sufficient support, place parts such as steel plates or cross ties under the supports in advance.
- b. If the ground is not level, adjust the height of the supports to level the platform. The supports are adjustable from 0–30 cm in height.



- c. During leveling, monitor the spirit level readings on the platform surface in real time. The suggestions for adjustment under various out-of-level conditions are as follows:

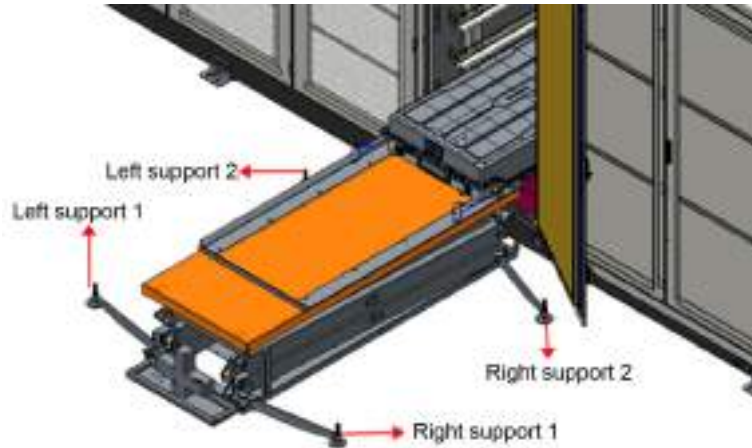

1. If the platform surface is low on the left and high on the right, raise the height of left support 1 or lower the height of right support 1.

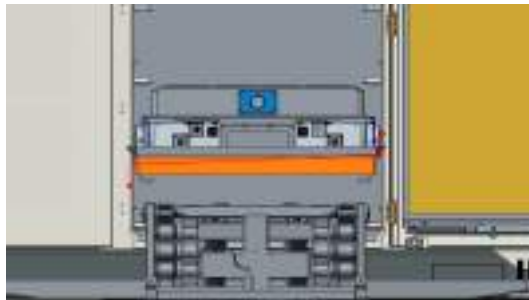

2. If the platform surface is high on the left and low on the right, lower the height of left support 1 or raise the height of right support 1.

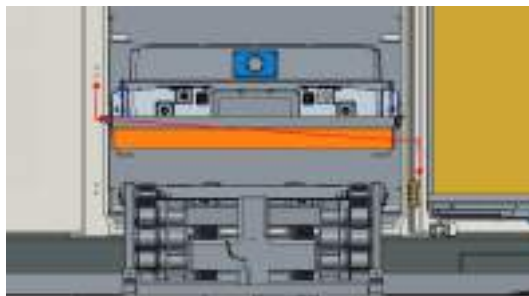

3. If the platform surface is high at the front and low at the rear, lower the height of left support 1 and right support 1, and raise the height of left support 2 and right support 2.



4. If the platform surface is low at the front and high at the rear, raise the height of left support 1 and right support 1, and lower the height of left support 2 and right support 2.

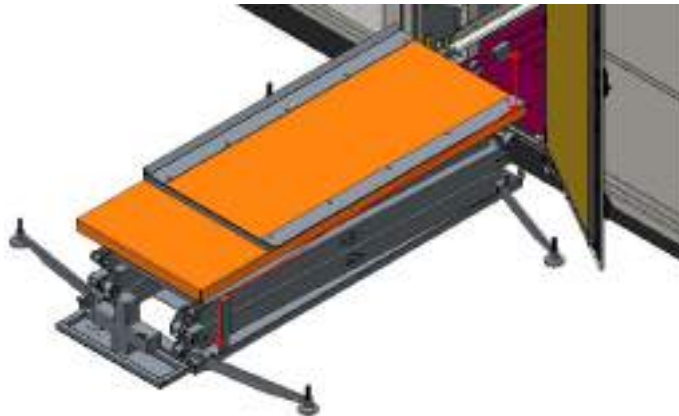

### Step 2 Raise the platform.

Step on the foot pedal of the lifting mechanism to raise the platform to a height 1–3 cm (recommended) lower than the Pack to be replaced. It is recommended to be 1 cm lower.

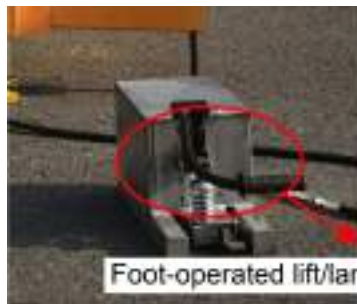

--End

### 5.3.4 Mount New Pack

### 5.3.4.1 Remove Old Pack

**Step 1** Remove the Pack from the cabinet by following the steps below.

- a. Attach the trapezoidal lead screw to the Pack.
- b. Rotate the hand wheel to pull out the Pack.



- c. When the Pack just comes out of the cabinet door, check from the side whether the bottom of the Pack is at a suitable height relative to the platform.
- d. Slightly adjust the height of the platform surface to ensure that the first rollers of the Pack land on the platform surface.
- e. During removal, the Pack's movement may shift the platform's center of gravity and change its levelness. The following are suggested platform adjustments for different load conditions, divided into three stages based on load level.
  - Stage 1 (low load level): The front end of the platform sinks. In this case, lift the platform by 5–8 mm to facilitate Pack removal.
  - Stage 2 (medium load level): As the Pack is pulled out, its front end may press against the platform, preventing further movement. In this case, lower the platform by 5–8 mm and check the first and second rollers, as shown in the figure below.

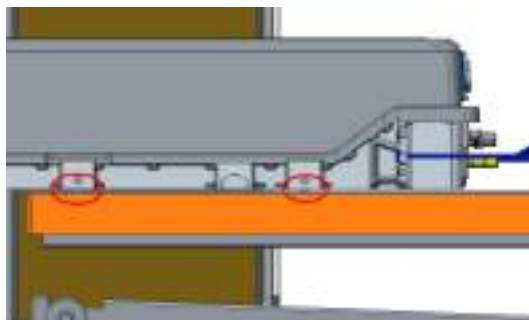

If the rollers are in the status below, lower the height of left support 2 and right support 2.



If the rollers are in the status below, raise the height of left support 2 and right support 2.



- Stage 3 (high load level): It is recommended to maintain the platform in the state shown below.



**Step 2** Transfer the Pack using the transport tooling and the forklift to the designated position.

#### NOTICE

**Do not lift the Pack above 1.5 m from the ground to prevent the risk of falling.**



--End

#### 5.3.4.2 Position New Pack

**Step 1** Confirm alignment: After the new Pack is landed on the platform surface, check whether the Pack is aligned with the cabinet. Alignment can be verified using the guide block at the

rear of the Pack. If the Pack is not aligned, lift it and adjust its position as shown in the figure below.

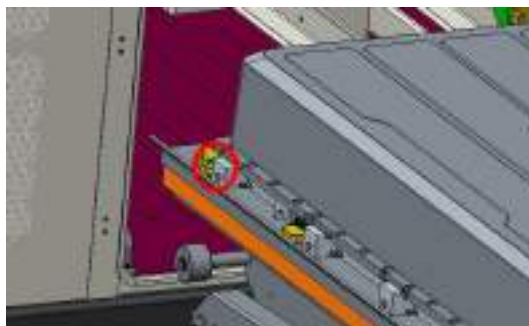
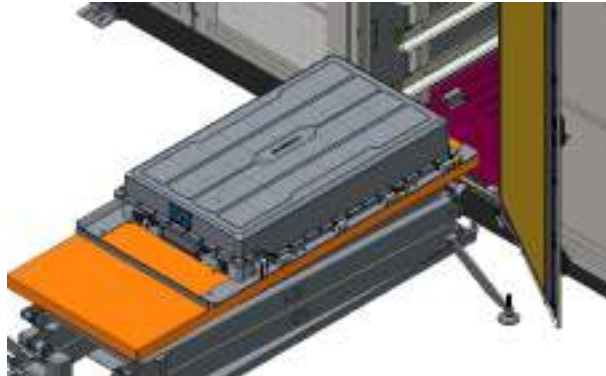

**Step 2** Adjust the platform surface. Changes and requirements of platform levelness when pushing in the Pack are the opposite of those when pulling it out. In the initial state, the platform surface shall be 1 cm (recommended) higher than the guide rail surface. The recommended initial platform setup is shown in the figure below (raise left support 1 and right support 1).



- Initial state: The platform surface is higher than the guide rail surface.



- When pushing the Pack into the cabinet, monitor the platform status by observing the rollers, following the instructions described for Pack removal.

--End

### 5.3.5 Follow-up Work

#### 5.3.5.1 Install Pack Angle Brackets

**Step 1** Secure the angle brackets in the designated positions on the Pack.



**Figure 5-11** Positions of Angle Brackets

\*The figure is for reference only.

**Step 2** Install the M8 screws on the angle brackets using a socket.

--End

#### 5.3.5.2 Install Fuse

##### Prerequisite

The position of the fuse is shown in the figure below.

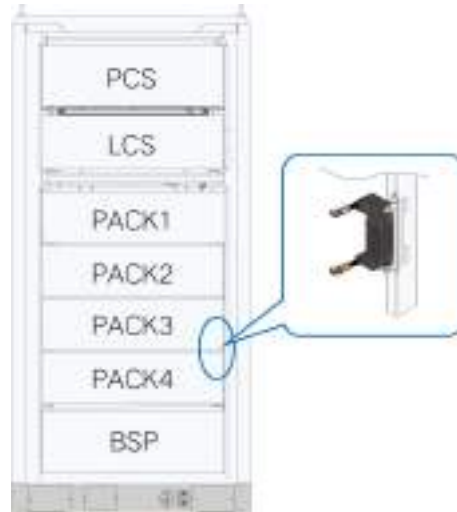

**Figure 5-12** Position of Fuse

\*The figure is for reference only.

**Step 1** Fit the M6 screws on the fuse. Do not tighten them immediately.



**Figure 5-13** Positions of Screw Holes

**Step 2** Insert the plugs of the fuse into the Pack bases.

**⚠ WARNING**

**Once the aviation plug is connected in place, you will hear a "click". Ensure that the connection is secure.**



- Insert the positive aviation plug into the designated positive socket on the Pack base, and the negative plug into the designated negative socket on the base. Orange indicates positive, and black indicates negative. Once the aviation plug is connected in place, you will hear a "click".
- When connecting the power cables, you can properly adjust the position of the fuse.

**Step 3** Once connection is complete, tighten the screws that are fit in Step 1.

--End

### 5.3.5.3 Connect Cables

**Step 1** Connect the power cables between the Packs.

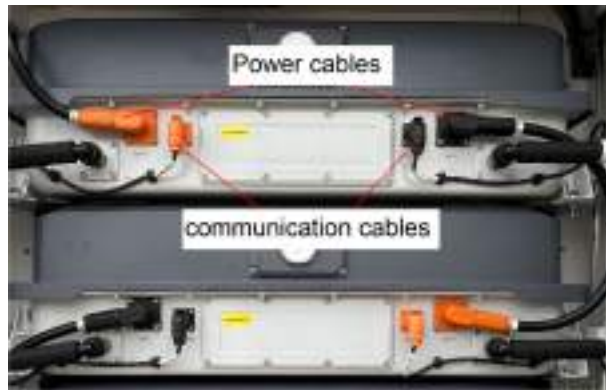

\*The figure is for reference only.

#### **⚠ WARNING**

**Once the aviation plug is connected in place, you will hear a "click". Ensure that the connection is secure.**



Insert the positive aviation plug into the designated positive socket on the Pack base, and the negative plug into the designated negative socket on the base. Orange indicates positive, and black indicates negative.

**Step 2** Connect the communication cables between the Packs.

--End

### 5.3.5.4 Install Liquid Cooling Pipes

#### **Prerequisite**

Before installation, inspect all connection points for foreign objects. If foreign objects are present, clean the connection points with purified water.

**Step 1** Take out the pipes from the inner side of the guide rail.

**Step 2** Connect the quick-connect fittings of the pipes.



**Figure 5-14** Positions of Liquid Cooling Pipe Fittings

\*The figure is for reference only.

--End

#### 5.3.5.5 Power On System

Power on the system after completing Pack replacement.

##### Prerequisite

Preparation for powering on: Before powering on the system, inspect all the equipment thoroughly and confirm that all the inspection items meet the requirements.

For the specific instructions, see [3.2 Power-on Procedure](#).

#### 5.3.5.6 Close Cabinet Door

##### Prerequisite

Inspect all the wiring thoroughly after completing all the work above. In addition, the following operations must also be performed:

- Secure the cabinet door, remove the key, and keep it under proper custody.
- Check that all air inlets and outlets are free from obstruction or blockage.

##### **⚠ WARNING**

- **Moisture may get in if the equipment is not properly sealed.**
- **Rodents may get in if the equipment is not properly sealed.**

## 5.4 Replace BSP

**Step 1** Shut down the system. For the specific instructions, see [5.3.2.3.2 Power Off System](#).

**Step 2** Remove the aviation plugs of the three-phase AC cables (U, V, and W) from the BSP.



**Figure 5-15** Position of Aviation Plugs of U/V/W Cables

\*The figure is for reference only.

**Step 3** Disconnect the power supply cable of the liquid cooling unit.



**Figure 5-16** Position of Power Supply Cable

\*The figure is for reference only.

**Step 4** Disconnect the cable from the network port.



**Figure 5-17** Position of Network Port

\*The figure is for reference only.

**Step 5** Disconnect the cables from CONN1–CONN4 terminals on the BSP.



**Figure 5-18** Position of CONN1–CONN4 Terminals

\*The figure is for reference only.

**Step 6** Remove the screws near the ends of the BSP handles.



**Figure 5-19** Position of Screws

\*The figure is for reference only.

- Step 7** Disconnect the grounding cable of the BSP.
  - Step 8** Grasp the foldable handles and pull the BSP out onto the wooden dunnage in front of the cabinet, then transfer it to a designated location.
  - Step 9** Place the new BSP on the dunnage in front of the cabinet. Adjust the position properly as per site conditions.
  - Step 10** Lift the rear of the BSP using the handles on both sides, rest it on the guide rails, and slide it into position.
  - Step 11** Install the M6 screws near the handles with a torque of  $(7.5 \pm 0.5)$  N·m.
  - Step 12** Reconnect the cables of the new BSP.
- End

## 5.5 Replace DC/AC Power Converter Unit

- Step 1** Shut down the system. For the specific instructions, see [5.3.2.3.2 Power Off System](#).
- Step 2** Remove the DC-side aviation plugs from the DC/AC power converter unit.



**Figure 5-20** Position of DC Aviation Plugs

\*The figure is for reference only.

**Step 3** Remove the AC-side aviation plugs (U, V, W, and N).



**Figure 5-21** Position of AC Aviation Plugs

\*The figure is for reference only.

**Step 4** Disconnect the communication cables.

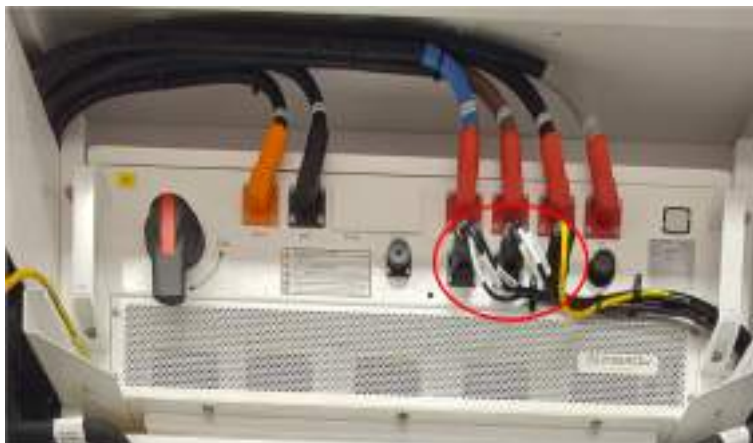

**Figure 5-22** Position of Communication Cables

\*The figure is for reference only.

**Step 5** Remove the screws near the ends of both handles of the DC/AC power converter unit.



**Figure 5-23** Positions of Screws

\*The figure is for reference only.

**Step 6** Disconnect the grounding cable of the DC/AC power converter unit.



**Figure 5-24** Position of Grounding Cable

\*The figure is for reference only.

- Step 7** Use a forklift and the maintenance tooling (or other suitable equipment). Lift the maintenance tooling platform to an appropriate height. Then, grasp the handles on the panel of the DC/AC power converter unit, and pull the unit out of the cabinet onto the tooling. Finally, lower the tooling to land the DC/AC power converter unit on the ground, and transfer the unit to a designated location.
- Step 8** Place the new DC/AC power converter unit onto the maintenance tooling. Lift the maintenance tooling platform to an appropriate height, then push the unit into the cabinet.
- Step 9** Install the M6 screws near the ends of the handles with a torque of  $(7.5 \pm 0.5)$  N·m.
- Step 10** Connect the cables of the new DC/AC power converter unit.
- End

## 5.6 Replace Liquid Cooling Unit

- Step 1** Drain coolant from the system. For the specific instructions, see [5.2.5 Drain Coolant](#).
- Step 2** Shut down the system. For the specific instructions, see [5.3.2.3.2 Power Off System](#).
- Step 3** Disconnect the power supply cable from the liquid cooling unit.



**Figure 5-25** Position of Power Supply Cable Plug

\*The figure is for reference only.

**Step 4** Disconnect the communication cable.



**Figure 5-26** Position of Communication Cable Plug

\*The figure is for reference only.

**Step 5** Remove the inlet and outlet pipes.



**Figure 5-27** Position of Inlet and Outlet Pipes

\*The figure is for reference only.

**Step 6** Remove the screws near the ends of the handles of the unit.



**Figure 5-28** Position of Screws

\*The figure is for reference only.

**Step 7** Disconnect the grounding cable.

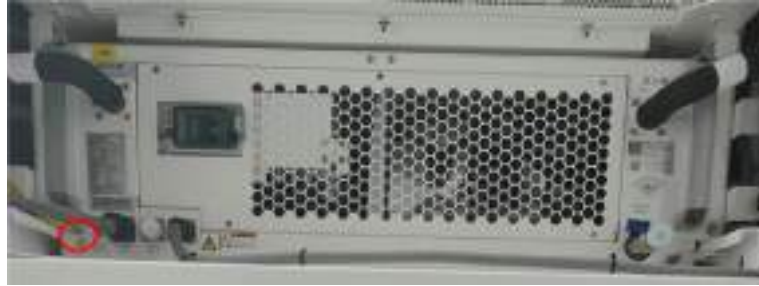

**Figure 5-29** Position of Grounding Cable

\*The figure is for reference only.

- Step 8** Use a forklift and the maintenance tooling (or other suitable equipment). Lift the maintenance tooling platform to an appropriate height. Then, grasp the handles on the panel of the liquid cooling unit and pull the unit out of the cabinet onto the tooling. Finally, lower the tooling to land the liquid cooling unit on the ground, and transfer it to a designated location.
- Step 9** Place the new liquid cooling unit onto the maintenance tooling. Lift the maintenance tooling platform to an appropriate height, then push the liquid cooling unit into the cabinet.
- Step 10** Install the M6 screws near the ends of the handles with a torque of  $(7.5 \pm 0.5)$  N·m.
- Step 11** Connect the cables of the new liquid cooling unit.
- End

## 5.7 Replace BMU

- Step 1** Remove the front cover of the Pack: Remove the eight bolts from the front cover using an appropriate tool, then remove the front cover. Properly keep the cover and bolts.

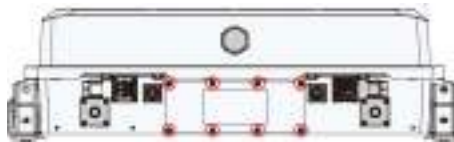

**Figure 5-30** BMU Front Cover

- Step 2** Remove the BMU board: Remove the bolts securing the BMU board and carefully pull out the communicable cables' plug connectors. Take care not to damage the connectors and prevent the cables from falling off.



**Figure 5-31** Installation Position of BMU Board

When removing the plug of the sampling cable, press the latch on the plug with your hand to disengage it first. It is recommended to press the lower end of the latch, as illustrated below, to reduce resistance and avoid connector damage.



**Figure 5-32** Plug Latch

Pressing the upper end of the latch is not recommended.



**Figure 5-33** Incorrect Practice

Press the lower end of the latch.



**Figure 5-34** Correct Practice

#### NOTICE

**For the purpose of illustrating the details, in the above figures, the operator is not wearing safety gloves. In actual operation, be sure to wear safety gloves and shoes!**

- Step 3** Replace the BMU board: Insert the communication cable plugs into the corresponding sockets and check that the connections are secure. Tighten the bolts to secure the BMU board, and reinstall the front cover. Check that the front cover is properly sealed. Connect the sampling cable plug of the Pack to the socket on the BMU board of the same color. Insert the plug vertically into the socket, with the latch facing outward. Follow the order: green → black → blue → white, and avoid reverse or cross connections.



**Figure 5-35** Connection Sequence of Sampling Cable Plugs

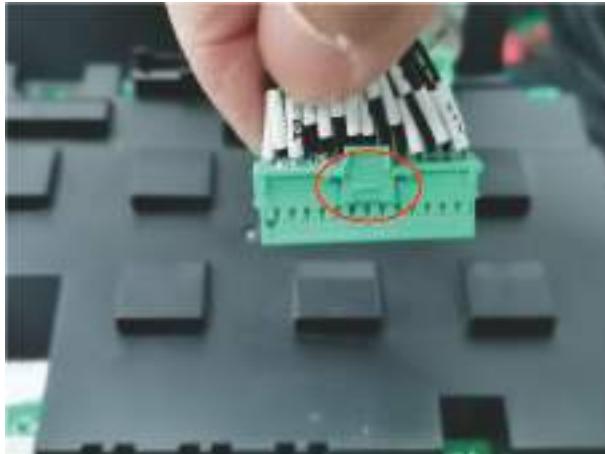

**Figure 5-36** Orient the Plug Latch Outward



**Figure 5-37** Insert the Plug Vertically with the Latch Facing Outward



**Figure 5-38** Ensure Secure Connection

**NOTICE**

For the purpose of illustrating the details, in the above figures, the operator is not wearing safety gloves. In actual operation, be sure to wear safety gloves and shoes!

--End

## 5.8 Replace Fuse

**Step 1** Unlock the two plugs of the fuse and remove them from the Packs.



**Step 2** Remove the two bolts securing the fuse.



**Step 3** After replacing the faulty fuse, install the new fuse and connect the fuse plugs to the Packs by reversing the removal steps.

--End



# 6 Troubleshooting

## 6.1 Overview

In case of anything abnormal with the ESS, it is suggested to perform troubleshooting by referring to the troubleshooting methods mentioned in this manual.

If the problem still persists or there are any other questions, please contact SUNGROW. It would be helpful if you could provide the below information:

- Model and S/N of the ESS and internal equipment
- Fault information and a brief description of the fault
- A photo of the fault, if possible

## 6.2 DC/AC Power Converter Unit Troubleshooting

Log in to the Web user interface of the LC. Navigate to **Operating information > PCS information** to view the Fault status or Alarm running status of the DC/AC power converter unit.

Fault	Fault Details	Suggestions	Note
Bus average undervoltage	<ul style="list-style-type: none"> <li>• Threshold 1: Vthreshold1 = (Minimum operating voltage 580 V - 30 V) * 0.9 - 50 V</li> <li>• Threshold 2: Vthreshold2 = Peak line voltage + 8 V</li> <li>• Threshold 3: Vthreshold3 = Peak line voltage - 20 V</li> <li>• Threshold 4: Vthreshold4 = Battery undervoltage protection threshold sent by ARM</li> </ul> <p>The following protections are blocked in open-loop mode, short-circuit ring mode, and non-operating state:</p>	After the fault is cleared, restart the device. If the fault persists, please contact SUNGROW.	After the protection is initiated, if the battery voltage Vdc exceeds max{Vthreshold2 + 2 V, Vthreshold4 + 5 V}, the fault is cleared after a 1 min delay.

Fault	Fault Details	Suggestions	Note
	<ol style="list-style-type: none"> <li>1. When bus capacitor voltage <math>V_{bus}</math> is below <math>V_{threshold1}</math>, protection is triggered after a 1 ms delay (rapid protection).</li> <li>2. When charging in grid-connected mode and <math>V_{bus}</math> is below <math>\max\{V_{threshold3}, V_{threshold4}\}</math>, the protection is triggered after a 1 s delay.</li> <li>3. When charging in grid-connected mode and <math>V_{bus}</math> is above <math>\max\{V_{threshold3}, V_{threshold4}\}</math> but below <math>V_{threshold2}</math>, if the charging power exceeds <math>0.7 P_n</math> or the charging current exceeds the charging current limit, protection is triggered after a 1 s delay.</li> <li>4. In other states, when <math>V_{bus}</math> is below <math>\max\{V_{threshold2}, V_{threshold4}\}</math>, protection is triggered after a 1 s delay.</li> </ol>		
High bus voltage	<ul style="list-style-type: none"> <li>• Threshold 1: <math>V_{threshold1} =</math> Maximum voltage 1550 V</li> <li>• Threshold 2: <math>V_{threshold2} =</math> Battery overvoltage protection threshold sent by ARM</li> </ul> <ol style="list-style-type: none"> <li>1. When the bus capacitor voltage <math>V_{bus}</math> exceeds <math>V_{threshold1}</math>, the protection is</li> </ol>	Check whether the bus overvoltage settings are correct. If the settings are appropriate and the fault persists, please contact SUNGROW.	After the protection is initiated, if $V_{bus}$ is below $\{V_{threshold2} - 20 V\}$ , the fault is cleared after a 30 s delay.

Fault	Fault Details	Suggestions	Note
	<p>triggered after a 1 ms delay (rapid protection).</p> <ol style="list-style-type: none"> <li>When Vbus exceeds Vthreshold2, the protection is triggered after a 50 ms delay.</li> </ol>		
<p>Grid undervoltage</p>	<ol style="list-style-type: none"> <li>If LVRT is enabled, the protection is triggered after the LVRT timeout.</li> <li>If LVRT is disabled, the protection is performed based on the level 5 undervoltage protection threshold and corresponding time delay. If islanding protection has been triggered, this protection is blocked.</li> </ol>	<p>Generally, the device will reconnect to the grid when the grid returns to normal.</p> <ol style="list-style-type: none"> <li>Measure the actual grid voltage. If it is below the set threshold, contact the power company.</li> <li>Check the protection parameter settings of the DC/AC power converter unit.</li> <li>If the grid voltage is within the normal range, check that all AC cables are securely connected.</li> <li>If the fault is not caused by the foregoing reasons and persists, please contact SUNGROW.</li> </ol>	<ol style="list-style-type: none"> <li>If an update is detected for the operating mode or the rated frequency setting, the fault is cleared immediately.</li> <li>If in VF mode or VSG mode, the fault is cleared after a 30 s delay after the protection is triggered and the device shuts down.</li> <li>After the protection is initiated, if the recovery threshold is met, the fault is cleared after the grid recovery time delay sent by ARM (1 min).</li> <li>If islanding protection is triggered, the fault is cleared immediately.</li> </ol>

Fault	Fault Details	Suggestions	Note
Grid overvoltage	<ol style="list-style-type: none"> <li>1. If HVRT is enabled, the protection is triggered after the HVRT timeout.</li> <li>2. If HVRT is disabled, the protection is performed based on the level 5 overvoltage protection threshold and corresponding time delay. If islanding protection has been triggered, this protection is blocked.</li> <li>3. In VF mode, if the presence of grid is detected, the protection is triggered after a 1 min delay.</li> <li>4. If the maximum transient three-phase line voltage exceeds the threshold (Rated peak line voltage * 1.45), the protection is triggered after a 1 ms delay (rapid protection).</li> <li>5. Applicable to Australian standards and valid when 10-minute overvoltage is enabled. When the voltage exceeds the threshold set by ARM (440 V by default), the protection is triggered after a 10 min delay.</li> </ol>	<p>Generally, the device will reconnect to the grid when the grid returns to normal.</p> <ol style="list-style-type: none"> <li>1. Measure the actual grid voltage. If it exceeds the set threshold, contact the power company.</li> <li>2. Check the protection parameter settings of the DC/AC power converter unit.</li> <li>3. If the fault is not caused by the foregoing reasons and persists, please contact SUNGROW.</li> </ol>	<ul style="list-style-type: none"> <li>• The grid voltage falls below the preset overvoltage recovery threshold, and remains below this threshold for longer than the preset grid recovery time.</li> <li>• Off-grid mode: The fault is automatically cleared 30 s after a protective shutdown.</li> </ul>
AC underfrequency	<p>The grid frequency remains below the level 1–5 protection thresholds for a period exceeding the preset underfrequency protection time delay.</p> <p>In off-grid mode:</p>	<p>Generally, the device will reconnect to the grid once the grid frequency returns to normal.</p>	<ul style="list-style-type: none"> <li>• Grid-connected mode: If the frequency remains above the underfrequency recovery</li> </ul>

Fault	Fault Details	Suggestions	Note
	<p>The AC underfrequency function is enabled only after the output voltage stabilizes. The protection action is the same as in grid-connected mode.</p>	<ol style="list-style-type: none"> <li>1. Check the actual grid frequency on the interface (or measure the frequency on the AC output side). If the grid frequency is below the preset threshold, please contact the power company.</li> <li>2. Check the protection parameter settings of the DC/AC power converter unit.</li> <li>3. If the fault is not caused by the foregoing reasons and persists, please contact SUNGROW.</li> </ol>	<p>threshold for a period exceeding the preset grid recovery time, the fault is cleared.</p> <ul style="list-style-type: none"> <li>• Off-grid mode: The fault is automatically cleared 30 s after shutdown.</li> </ul>
<p>AC overfrequency</p>	<p>The grid frequency exceeds the level 1–5 protection thresholds for a period exceeding the preset overfrequency protection time delay.</p> <p>In off-grid mode: The AC overfrequency function is enabled only after the output voltage stabilizes. The protection</p>	<p>Generally, the device will reconnect to the grid once the grid frequency returns to normal.</p> <ol style="list-style-type: none"> <li>1. Check the actual grid frequency on the interface (or measure</li> </ol>	<ul style="list-style-type: none"> <li>• Grid-connected mode: The frequency remains below the overfrequency recovery threshold for a period exceeding the</li> </ul>

Fault	Fault Details	Suggestions	Note
	<p>action is the same as in grid-connected mode.</p>	<p>the frequency on the AC output side). If the grid frequency exceeds the preset threshold, please contact the power company.</p> <ol style="list-style-type: none"> <li>2. Check the protection parameter settings of the DC/AC power converter unit.</li> <li>3. If the fault is not caused by the foregoing reasons and persists, please contact SUNGROW.</li> </ol>	<p>preset grid recovery time.</p> <ul style="list-style-type: none"> <li>• Off-grid mode: The fault is automatically cleared 30 s after a protective shutdown.</li> </ul>
AC relay fault	<p>The protection is decided and performed based on the self-test procedure of the AC relay. If the self-test fails three consecutive times, the protection is triggered.</p>	<p>Wait for the DC/AC power converter unit to return to normal. If the fault persists, manually power off and clear the fault.</p>	<p>Wait 3 minutes; the system will then clear the fault automatically. The fault can be automatically cleared up to 5 times. If this limit is exceeded, manually power off and reset the fault.</p>
Islanding protection	<p>Passive islanding:</p> <ol style="list-style-type: none"> <li>1. If the peak voltage is less than 0.25 times the maximum peak voltage,</li> </ol>	<ol style="list-style-type: none"> <li>1. Check whether the grid power</li> </ol>	<ol style="list-style-type: none"> <li>1. If an update is detected for the operating mode or the</li> </ol>

Fault	Fault Details	Suggestions	Note
	<p>or the frequency jump exceeds 0.3 Hz, the protection is triggered after a 200 ms delay.</p> <p>2. If the peak voltage is less than 0.2 times the maximum peak voltage, the protection is triggered after a 5 s delay.</p> <p>Active islanding;</p> <ul style="list-style-type: none"> <li>Record the maximum frequency deviation <math>\Delta f</math> within every 400 ms. If <math>\Delta f</math> is greater than or equal to 8 Hz, an alarm is triggered immediately (For Japan, if <math>\Delta f</math> is greater than or equal to 5 Hz, an alarm is triggered after a 500 ms delay.)</li> </ul>	<p>supply is normal.</p> <p>2. Check whether the AC cables are firmly connected.</p> <p>3. Check whether the AC cables are connected to the correct terminals.</p> <p>4. Check whether the AC circuit breaker is closed.</p> <p>5. If the fault is not caused by the foregoing reasons and persists, please contact SUNGROW.</p>	<p>rated frequency setting, the fault is cleared immediately.</p> <p>2. If in VF mode or VSG mode, the fault is cleared after a 30 s delay after the protection is triggered and the device shuts down.</p> <p>3. After protection is initiated, if the peak voltage is greater than 0.7 times the maximum peak voltage and the RMS value is greater than 0.5 times, the fault is cleared after a grid recovery time delay (1 min) sent by ARM.</p>
<p>Residual current protection</p>	<p>In VSG mode, parallel connection mode, and during HVRT or LVRT conditions, no detection is performed. Generally, detection begins after a preset time delay once the system is powered on.</p> <ul style="list-style-type: none"> <li>Threshold 1: 30 ms, 120 ms, 240 ms sliding window filter value.</li> <li>Threshold 2:</li> </ul>	<p>1. Check if the Packs are exposed to rainy or humid weather. If so, there is no need to worry.</p> <p>2. Check for any poor contacts in the Packs.</p> <p>3. Check the protection</p>	<p>The static leakage current value is lower than the preset threshold. Wait 1 minute; the system will then clear the fault automatically.</p>

Fault	Fault Details	Suggestions	Note
	<ol style="list-style-type: none"> <li>1. The protection is triggered if the 30 ms sliding window filter value exceeds 150 mA, the 120 ms sliding window filter value exceeds 60 mA, or the 240 ms sliding window filter value exceeds 30 mA.</li> <li>2. If the detected leakage current exceeds 0.9 times the protection threshold, the protection is triggered after a 240 ms delay.</li> <li>3. When the RCD self-test is enabled, the detected leakage current remains between the upper and lower limits; otherwise, the protection is triggered after a delay.</li> </ol>	<p>parameter settings of the DC/AC power converter unit.</p> <ol style="list-style-type: none"> <li>4. If the fault is not caused by the foregoing reasons and persists, please contact SUNGROW.</li> </ol>	
Output overload	<p>GB/T 34120 requires that the operating time at 1.1x overload be no less than 10 minutes, and at 1.2x overload no less than 1 minute.</p> <ul style="list-style-type: none"> <li>• Threshold 1: Lthreshold1 = 1.15 Pn</li> <li>• Threshold 2: Lthreshold2 = 1.2 Pn</li> <li>• Threshold 3: Lthreshold3 = 1.15 In</li> </ul>	Wait for the inverter to return to normal.	Wait 3 minutes; the system will then clear the fault automatically.

Fault	Fault Details	Suggestions	Note
	<ul style="list-style-type: none"> <li>• Threshold 4: Lthreshold4 = 1.2 In</li> </ul> <ol style="list-style-type: none"> <li>1. If the apparent power exceeds Lthreshold1 or the maximum three-phase current (RMS value) exceeds Lthreshold3, the protection is triggered after a 10 min delay.</li> <li>2. If the apparent power exceeds Lthreshold2 or the maximum three-phase current (RMS value) exceeds Lthreshold4, the protection is triggered after a 1 min delay.</li> </ol>		
DC overcurrent	If the DC current exceeds the threshold of 318 A (212 * 1.5), the protection is triggered after a 200 ms delay.	Generally, the fault is cleared automatically, and no further action is required. If the fault occurs repeatedly, please contact SUNGROW.	Wait 3 minutes; the system will then clear the fault automatically.
Transient AC overcurrent	If the transient three-phase current exceeds the threshold of 537 A (190 * 2 * 1.414), the protection is triggered after a 1 ms delay.	Generally, the fault is cleared automatically, and no further action is required. If the fault occurs repeatedly, please contact SUNGROW.	Wait 3 minutes; the system will then clear the fault automatically.
Ambient temperature abnormal	The ambient temperature exceeds 82°C.	Generally, the device will reconnect to the grid when the internal	The fault is cleared once the ambient temperature drops below 67°C.

Fault	Fault Details	Suggestions	Note
		<p>temperature returns to normal. If the fault repeatedly occurs:</p> <ol style="list-style-type: none"> <li>1. Check whether the ambient temperature of the device is too high.</li> <li>2. Check whether the location of the device is well-ventilated.</li> <li>3. Check whether the device is exposed to direct sunlight; if so, provide sunshades for it.</li> <li>4. Check whether the fan is running properly. If not, replace the fan.</li> <li>5. If the fault is not caused by the foregoing reasons and persists, please contact SUNGROW.</li> </ol>	
Hardware fault	<ol style="list-style-type: none"> <li>1. If the HW_FAULT (GPIO88) shows low level, the protection is</li> </ol>	Generally, the fault is cleared automatically, and	Wait 3 minutes; the system will

Fault	Fault Details	Suggestions	Note
	<p>triggered after a 1 ms delay.</p>	<p>no further action is required. If the fault occurs repeatedly, please contact SUNGROW.</p>	<p>then clear the fault automatically.</p>
<p>Insulation resistance</p>	<p>1. When ISO permanent protection is disabled or DC parallel connection mode is enabled, this protection is blocked.</p> <p>2. Perform ISO detection and calculation. If the value is below the protection threshold, perform detection again. If the value fails to reach the threshold for three times, the protection is triggered.</p>	<p>Generally, this fault is cleared automatically and no further action is required. If the fault persists and the device cannot be connected to the grid normally:</p> <ol style="list-style-type: none"> <li>1. Check whether the ISO protection threshold set for the device is too high, and confirm that it meets the requirements.</li> <li>2. Check whether it is cloudy or rainy. Measure the negative- and positive-to-ground insulation resistance of the ESS and check if it is too low.</li> <li>3. If the fault is not caused by the foregoing reasons and</li> </ol>	<p>Wait 3 minutes. The system will clear the fault automatically and perform detection again.</p>

Fault	Fault Details	Suggestions	Note
		persists, please contact SUNGROW.	
AC SPD fault	The AC SPD node signal remains abnormal for 200 ms.	<ol style="list-style-type: none"> <li>1. Check whether the SPD is loose or damaged. Replace the SPD in case of any damage.</li> <li>2. If the fault is not caused by the foregoing reasons and persists, please contact SUNGROW.</li> </ol>	After protection is initiated, if the feedback IO level is high, the fault is cleared after a 30 s delay.
Analog offset abnormal	During the power-on and initialization phase, after completing the AD offset calibration, test the AD values of the three-phase current and DC current. If the value exceeds the limit for three times, the protection is triggered.	<ol style="list-style-type: none"> <li>1. Restart the DC/AC power converter unit.</li> <li>2. Check whether the internal connection is loose and whether the current sensor fails.</li> <li>3. If the fault is not caused by the foregoing reasons and persists, please contact SUNGROW.</li> </ol>	This fault cannot be cleared automatically. Manually check the fault and restart the system after troubleshooting.

Fault	Fault Details	Suggestions	Note
Battery reverse polarity	If the sampled battery voltage Vdc is less than -100 V, the protection is triggered after a 500 ms delay.	Check whether the DC cables are correctly connected.	This fault cannot be cleared automatically. Manually check the fault and restart the system after troubleshooting.
AC current unbalance	In grid-connected mode and without voltage ride-through, calculate the difference between the maximum and minimum three-phase current RMS values. If it exceeds 0.15 times the rated value, the protection is triggered after a 200 ms delay (700 ms in Japan).	<ol style="list-style-type: none"> <li>1. Wait for the device to return to normal.</li> <li>2. If the fault persists, please contact SUNGROW.</li> </ol>	The three-phase current difference remains below 5% of the rated current for 20 s.
DC SPD fault	The DC SPD node signal remains abnormal for 200 ms.	<ol style="list-style-type: none"> <li>1. Check whether the SPD is loose or damaged. Replace the SPD in case of any damage.</li> <li>2. If the fault is not caused by the foregoing reasons and persists, please contact SUNGROW.</li> </ol>	After protection, if the feedback IO level is high, the fault will be cleared after a 30 s delay.
DC soft start fault	During the charging phase of startup, after closing the charge contactor K0 and the negative bus contactor K3, if the voltage difference between the battery and the	Restart the device. If the fault persists, please contact SUNGROW.	After protection and shutdown, the fault is cleared after a 3 min delay.

Fault	Fault Details	Suggestions	Note
AC voltage unbalance	capacitor remains above 80 V for 2 minutes, the protection is triggered.		
	<ol style="list-style-type: none"> <li>1. Blocked if islanding protection has been triggered.</li> <li>2. Calculate the difference between the maximum and minimum three-phase line voltage RMS values. If the value exceeds the threshold (sent by ARM), the protection is triggered after a delay (sent by RAM).</li> </ol>	<p>Generally, the device will reconnect to the grid when the grid returns to normal. If the fault occurs repeatedly:</p> <ol style="list-style-type: none"> <li>1. Measure the actual grid voltage at AC output. If the grid voltage unbalance exceeds the preset threshold, please contact the power company.</li> <li>2. Check whether the grid voltage unbalance parameters are properly set.</li> <li>3. If the fault is not caused by the foregoing reasons and persists, please contact SUNGROW.</li> </ol>	<ol style="list-style-type: none"> <li>1. If an update is detected for the operating mode or the rated frequency setting, the fault is cleared immediately.</li> <li>2. If in VF mode or VSG mode, the fault is cleared after a 30 s delay after the protection is triggered and the device shuts down.</li> <li>3. If islanding protection is triggered, the fault is cleared immediately.</li> <li>4. Calculate the difference between the maximum and minimum three-phase line voltage RMS values. If the value is below 0.02 Un, the fault is cleared after the grid recovery time delay (1 min) sent by ARM.</li> </ol>

Fault	Fault Details	Suggestions	Note
<p>Inversion open-loop self-test fault</p>	<p>During startup, at the AC soft start stage, if AC soft start fails to complete within 30 s, the protection is triggered.</p>	<p>If the fault persists after multiple startup attempts, please contact SUNGROW.</p>	<p>After protection and shutdown, the fault is cleared after a 3 min delay. The fault can be automatically cleared up to 5 times.</p>
<p>Carrier synchronization fault</p>	<ul style="list-style-type: none"> <li>• Blocked if the device is not in parallel connection mode or DC parallel connection mode.</li> <li>• IO signal protection: If the carrier communication IO shows low level, after a 200 ms delay:                             <ol style="list-style-type: none"> <li>1. If the system is running, the protection is triggered.</li> <li>2. If the system is in other states and the battery voltage Vdc exceeds 200 V, the protection is triggered after an additional 5 min delay.</li> </ol> </li> </ul>	<ol style="list-style-type: none"> <li>1. Try powering off and restarting the device.</li> <li>2. Check the carrier synchronization wiring for loose connection.</li> <li>3. If the fault is not caused by the foregoing reasons and persists, please contact SUNGROW.</li> </ol>	<ol style="list-style-type: none"> <li>1. The fault is cleared if the device is not in parallel connection mode or DC parallel connection mode.</li> <li>2. If the carrier communication IO shows high level, the fault is cleared after a 10 s delay.</li> </ol>
<p>Bus voltage unbalance</p>	<p>If the half-bus voltage exceeds the protection threshold of 617.5 V, or the difference between the positive and negative bus voltages exceeds the protection threshold of 200 V, the protection is triggered after a 1 s delay.</p>	<p>Generally, the device will restore to normal and connect to the grid in several minutes. If the fault occurs repeatedly, please contact SUNGROW.</p>	<p>If the half-bus voltage drops below the protection threshold, or the difference between the positive and negative bus voltages drops</p>

Fault	Fault Details	Suggestions	Note
			below the protection threshold, the fault is cleared after a 30 s delay.
Running under GFRT condition	The alarm is triggered in case of HVRT or LVRT.	<ol style="list-style-type: none"> <li>1. This is an alarm and the device can keep operating risk-free.</li> <li>2. Restart the device. If the fault persists, please contact SUNGROW.</li> </ol>	<ol style="list-style-type: none"> <li>1. The alarm is cleared when the device stops running.</li> <li>2. The alarm is cleared after a 2 s delay when HVRT or LVRT ends.</li> </ol>
Charging conditions not met	If charging conditions are not met (in constant-current grid connection or constant-power mode, the battery voltage exceeds charging voltage upper limit + 2 V and the current or power command is charging), the protection is triggered after a 3 s delay.	<ol style="list-style-type: none"> <li>1. This is an alarm. Check whether the parameters are correctly set.</li> <li>2. Check whether the actual output voltage of the battery is abnormal.</li> <li>3. If the alarm is not caused by the foregoing reasons and persists, please contact SUNGROW.</li> </ol>	When charging conditions are met, the alarm is cleared after a 300 ms delay.
Discharging condition	If discharging conditions are not met (in constant-current or constant-power mode, the battery voltage is lower	<ol style="list-style-type: none"> <li>1. This is an alarm. Check whether the parameters</li> </ol>	When discharging conditions are met, the alarm is

Fault	Fault Details	Suggestions	Note
ns not met	than discharging voltage limit - 2 V and the current or power command is discharging), the protection is triggered after a 3 s delay.	<p>are correctly set.</p> <ol style="list-style-type: none"> <li>2. Check whether the actual output voltage of the battery is abnormal.</li> <li>3. If the alarm is not caused by the foregoing reasons and persists, please contact SUNGROW.</li> </ol>	cleared after a 300 ms delay.
Fan anomaly	During operation, if the fan drive pulse duty cycle is greater than 0.2 while the fan speed is 0 for 10 seconds:	<p>Check the fans. Shut down the device, disconnect the device's power supply and remove any foreign objects. If the fan is damaged, please replace it.</p>	The fan speed is not 0.
Module overtemperature	If the maximum IGBT temperature exceeds the threshold of 107°C, the protection is triggered after a 100 ms delay.	<p>Generally, the device will connect to the grid again when its internal temperature or module temperature returns to normal. If the fault occurs repeatedly:</p> <ol style="list-style-type: none"> <li>1. Check whether the ambient</li> </ol>	After the protection is initiated, if the maximum IGBT temperature is below 70°C, the fault is cleared after a 5 s delay.

Fault	Fault Details	Suggestions	Note
		<p>temperature is too high.</p> <ol style="list-style-type: none"> <li>2. Check whether the location of the device is well-ventilated.</li> <li>3. Check whether the device is exposed to direct sunlight; if so, provide sunshades for it.</li> <li>4. Check whether the fan is running properly. If not, replace the fan.</li> <li>5. If the fault is not caused by the foregoing reasons and persists, please contact SUNGROW.</li> </ol>	
DC contactor fault	<ol style="list-style-type: none"> <li>1. This fault detection is executed only during the first power-on and only if contactor self-test is enabled. The protection is triggered if contact welding is detected in K1 or K3.</li> <li>2. During the charging phase of startup, after closing the main contactor K1, if</li> </ol>	<ol style="list-style-type: none"> <li>1. Check whether contactors K1 and K3 are abnormal.</li> <li>2. If the fault is not caused by the foregoing reasons and persists, please</li> </ol>	<p>After protection and shutdown, the fault is cleared after a 3 min delay. The fault can be automatically cleared up to 3 times.</p>

Fault	Fault Details	Suggestions	Note
	<p>the voltage difference between the battery and the capacitor remains above 30 V for 2 minutes, the protection is triggered.</p> <p>3. During operation, if the voltage difference between the bus voltage Vbus and the battery voltage Vdc exceeds 50 V, the protection is triggered after a 100 ms delay.</p>	<p>contact SUNGROW.</p>	
<p>DC component limit exceeded</p>	<p>When this protection is enabled and no voltage ride-through is triggered, if the detected DC component in the AC current exceeds the preset protection threshold, the protection is triggered after the preset protection delay.</p>	<ol style="list-style-type: none"> <li>1. Check whether the related protection parameters are set correctly.</li> <li>2. If the fault is not caused by the foregoing reasons and persists, please contact SUNGROW.</li> </ol>	<p>After protection and shutdown, if the detected DC component in the AC current drops below preset protection threshold * 0.5, the fault is cleared after a 10 s delay.</p>
<p>Duplicate address code fault</p>	<ol style="list-style-type: none"> <li>1. Blocked if the device is not the master in parallel connection mode.</li> <li>2. A phase flag error is detected in the master in parallel connection mode. The protection is triggered after a 1 s delay.</li> </ol>	<ol style="list-style-type: none"> <li>1. Check if there are duplicate address codes.</li> <li>2. If the fault is not caused by the foregoing reasons and persists, please contact SUNGROW.</li> </ol>	<p>-</p>

Fault	Fault Details	Suggestions	Note
Parallel communication fault	<p>Blocked if the device is not in parallel connection mode or if the device is the master in parallel connection mode.</p> <ol style="list-style-type: none"> <li>In running state, the protection is triggered if the total communication failure count exceeds 10.</li> <li>In other states, the protection is triggered if the total communication failure count exceeds 3000.</li> </ol>	<ol style="list-style-type: none"> <li>Try powering off and restarting the device.</li> <li>Check the parallel communication cables for loose connection.</li> <li>If the fault is not caused by the foregoing reasons and persists, please contact SUNGROW.</li> </ol>	<ol style="list-style-type: none"> <li>The fault is cleared if the device is not in parallel connection mode or if the device is the master in parallel connection mode.</li> <li>After the protection is initiated, if the total communication failure count is less than 4, the fault is cleared after a 30 s delay.</li> </ol>
AC incoming line phase sequence error	<p>When the country code is GB/T 34120 or when the system is operating in VSG mode, if negative grid phase sequence is detected, the protection is triggered.</p>	<p>Check the wiring of AC phase A, B, and C terminals. Ensure the wiring phase sequence is correct.</p>	<p>This fault cannot be cleared automatically. Manually check the fault and restart the system after troubleshooting.</p>
Battery current sampling abnormal	<p>If the difference between AC-side active power and DC-side active power exceeds 10% of rated power, the protection is triggered after a 500 ms delay.</p>	<ol style="list-style-type: none"> <li>Check if the battery current sampling circuit is functioning properly.</li> <li>If the fault is not caused by the foregoing reasons and persists,</li> </ol>	<p>This fault cannot be cleared automatically. Manually check the fault and restart the system after troubleshooting.</p>

Fault	Fault Details	Suggestions	Note
		please contact SUNGROW.	

## 6.3 Battery Troubleshooting

Fault	Trigger Conditions	Suggestions
Cell overvoltage fault	The cell voltage remains above the preset fault threshold.	1. Check whether the BSC parameters are correctly set. 2. Check whether the cell voltage is abnormal. 3. Check whether the voltage sampling cable is abnormal.
Pack overvoltage fault	The Pack voltage remains above the preset fault threshold.	1. Check whether the BSC parameters are correctly set. 2. Check whether the cell voltage is abnormal. 3. Check whether the voltage sampling cable is abnormal.
Total voltage overvoltage fault	The Rack total voltage remains above the preset fault threshold.	1. Check whether the BSC parameters are correctly set. 2. Check whether the cell voltage is abnormal. 3. Check whether the voltage sampling cable is abnormal.
Cell undervoltage fault	The cell voltage remains below the preset fault threshold.	1. Check whether the BSC parameters are correctly set. 2. Check whether the cell voltage is abnormal. 3. Check whether the voltage sampling cable is abnormal.
Pack undervoltage fault	The Pack voltage remains below the preset fault threshold.	1. Check whether the BSC parameters are correctly set. 2. Check whether the cell voltage is abnormal.

Fault	Trigger Conditions	Suggestions
Total voltage undervoltage fault	The Rack voltage remains below the preset fault threshold.	<ol style="list-style-type: none"> <li>1. Check whether the BSC parameters are correctly set.</li> <li>2. Check whether the cell voltage is abnormal.</li> <li>3. Check whether the HV sampling circuit or hardware of the CMU motherboard is abnormal.</li> </ol>
Cell low temperature fault	The cell temperature remains below the preset fault threshold during charging or discharging.	<ol style="list-style-type: none"> <li>1. Check whether the liquid cooling unit is enabled for heating.</li> <li>2. Check whether the battery compartment is properly sealed.</li> <li>3. Check whether the cell temperature sensor is properly connected.</li> </ol>
Cell overtemperature fault	The cell temperature remains above the preset fault threshold.	<ol style="list-style-type: none"> <li>1. Check whether the liquid cooling unit is enabled for cooling.</li> <li>2. Check whether the battery compartment is properly sealed.</li> <li>3. Check whether the battery power cables are properly connected.</li> <li>4. Check whether the cells in Pack have cold solder joints.</li> <li>5. Check whether the cell temperature sensor is properly connected.</li> </ol>
Overcurrent fault	The current remains above the preset fault threshold.	<ol style="list-style-type: none"> <li>1. Check whether the BSC parameters are correctly set.</li> <li>2. Check whether the system power cables are properly connected.</li> </ol>
Voltage sampling fault	Voltage sampling anomaly; sampling cable disconnection; BMU hardware fault	<ol style="list-style-type: none"> <li>1. Check whether the BMU is damaged. Replace it if it is damaged.</li> <li>2. Check the voltage sampling cable for disconnection.</li> </ol>
Temperature sampling fault	Temperature sampling anomaly; sampling cable disconnection; BMU hardware fault	<ol style="list-style-type: none"> <li>1. Check whether the BMU is damaged. Replace it if it is damaged.</li> <li>2. Check the temperature sampling cable for disconnection.</li> <li>3. Check the temperature sensor for failure.</li> </ol>
Current sampling fault	Current sampling anomaly; sampling	Check the current sampling cable for disconnection.

Fault	Trigger Conditions	Suggestions
	cable disconnection; CMU fault	
CMU-BMU communication fault	Communication cable disconnection; BMU damage.	<ol style="list-style-type: none"> <li>1. Check whether the communication cables are properly connected to the correct positions.</li> <li>2. Check whether the first BMU without communication is damaged (This module is skipped during communication cable connection.)</li> <li>3. Check the CMU for damage.</li> </ol>
CMU-BSC communication fault	Communication cable disconnection; BSC damage; CAN termination resistor not connected.	<ol style="list-style-type: none"> <li>1. Check whether the communication cable is properly connected.</li> <li>2. Check whether the CAN termination resistor is installed.</li> <li>3. Check the CMU and the BSC for damage.</li> </ol>
Fuse fault	Short circuit; prolonged overload; loose feedback signal cable; defective fuse; CMU fault.	<ol style="list-style-type: none"> <li>1. Check whether the fuse is blown. Replace it if so.</li> <li>2. Check the wiring for loose connection.</li> </ol>
Total voltage difference fault	The difference between the sum of voltages and the sampled total voltage exceeds the preset fault threshold, or the total voltage sampling circuit is abnormal; CMU fault.	<ol style="list-style-type: none"> <li>1. Check for other system faults such as communication faults and voltage sampling faults.</li> <li>2. Check the total voltage sampling cable for loose connection.</li> </ol>
Cell overvoltage alarm	The cell voltage remains above the preset alarm threshold.	<ol style="list-style-type: none"> <li>1. Stop charging for 5 minutes (or start discharging the system), and check whether the alarm is automatically cleared.</li> <li>2. Check whether the BSC parameters are correctly set.</li> <li>3. Check whether the cell voltage is abnormal.</li> </ol>

Fault	Trigger Conditions	Suggestions
		4. Check the voltage sampling cables for abnormal condition.
Pack overvoltage alarm	The Pack voltage remains above the preset alarm threshold.	1. Stop charging for 5 minutes (or start discharging the system), and check whether the alarm is automatically cleared. 2. Check whether the BSC parameters are correctly set. 3. Check whether the cell voltage is abnormal.
Total voltage overvoltage alarm	The Rack total voltage remains above the preset alarm threshold.	1. Stop charging for 5 minutes (or start discharging the system), and check whether the alarm is automatically cleared. 2. Check whether the BSC parameters are correctly set. 3. Check whether the cell voltage is abnormal.
Cell undervoltage alarm	The cell voltage remains below the preset alarm threshold.	1. Stop discharging for 5 minutes (or start charging the system), and check whether the alarm is automatically cleared. 2. Check whether the BSC parameters are correctly set. 3. Check whether the cell voltage is abnormal. 4. Check the voltage sampling cables for abnormal condition.
Pack undervoltage alarm	The Pack voltage remains below the preset alarm threshold.	1. Stop discharging for 5 minutes (or start charging the system), and check whether the alarm is automatically cleared. 2. Check whether the BSC parameters are correctly set. 3. Check whether the cell voltage is abnormal.
Total voltage undervoltage alarm	The Rack total voltage remains	1. Stop discharging for 5 minutes (or start charging the system), and check

Fault	Trigger Conditions	Suggestions
	below the preset alarm threshold.	whether the alarm is automatically cleared. 2. Check whether the BSC parameters are correctly set. 3. Check whether the cell voltage is abnormal.
Cell voltage difference alarm	The difference between the sampled maximum and minimum cell voltages of the Rack remains above the preset alarm threshold.	1. Check whether the system SOC is too low. The alarm will be automatically cleared after the SOC returns to a normal level. 2. Check for cell unbalance (refer to the Maintenance Manual if unbalance occurs). 3. Check the BMU for abnormal conditions. Replace it if it is abnormal. 4. Check whether the cell voltage is abnormal. 5. Check the voltage sampling cables for disconnection.
Pack voltage difference alarm	The difference between the maximum and minimum Pack voltages remains above the preset alarm threshold.	1. Check the cells of the Pack for overcharging or overdischarging. 2. Check the BMU for abnormal conditions. Replace it if it is abnormal.
Cell temperature difference alarm	The difference between the sampled maximum and minimum cell temperatures of the Rack remains above the preset alarm threshold.	1. Check whether the alarm is automatically cleared after the operating power of the DC/AC power converter unit decreases. 2. Check whether the liquid cooling unit is normally operating. 3. Check the power cables for loose connection. 4. Check whether the cells in the Pack have cold solder joints.
Cell low temperature alarm	The cell temperature remains below the preset alarm threshold during	1. Check whether the system has started up. After the startup is complete, check whether the alarm is automatically cleared.

Fault	Trigger Conditions	Suggestions
	charging or discharging.	<ol style="list-style-type: none"> <li>2. Check whether the liquid cooling unit is enabled for heating.</li> <li>3. Check the cell temperature sensor for abnormal conditions.</li> <li>4. Check whether the battery compartment is properly sealed.</li> </ol>
Cell overtemperature alarm	The cell temperature remains above the preset alarm threshold.	<ol style="list-style-type: none"> <li>1. Check whether the alarm is automatically cleared after the operating power of the DC/AC power converter unit decreases.</li> <li>2. Check whether the liquid cooling unit is enabled for cooling.</li> <li>3. Check the cell temperature sensor for abnormal conditions.</li> <li>4. Check whether the battery compartment is properly sealed.</li> <li>5. Check whether the battery power cables are properly connected.</li> <li>6. Check whether the cells in the Pack have cold solder joints.</li> </ol>
Overcurrent alarm	The current remains above the preset alarm threshold.	<ol style="list-style-type: none"> <li>1. Check for Rack unbalance. If an unbalance event occurs during initial installation, leave the system resting in standby mode for at least 24 hours.</li> <li>2. Check whether the alarm occurs when the SOC is low during discharging. If the alarm automatically clears after the SOC returns to a normal level, it is recommended to lower the depth of discharge.</li> <li>3. Check whether the power connections of the system are normal, whether there is a significant temperature difference within the battery system, and whether the liquid cooling unit is abnormal.</li> </ol>

\*If the fault persists after troubleshooting, please contact SUNGROW.

## 6.4 LC Troubleshooting

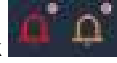

Log in to the LC Web user interface. Click  to view the fault and alarm information.

Fault	Fault Cause	Suggestions
LC-CMU communication fault	The communication is interrupted	<ul style="list-style-type: none"> <li>Immediately shut down the faulty system and disconnect its external power supply.</li> <li>Check whether the communication cables are loose.</li> </ul>
LC-DC/AC power converter unit (PCS) communication fault	The communication is interrupted	<ul style="list-style-type: none"> <li>Immediately shut down the faulty system and disconnect its external power supply.</li> <li>Check whether the communication cables are loose.</li> </ul>
Upper computer communication fault	The communication is interrupted	<ul style="list-style-type: none"> <li>Immediately shut down the faulty system and disconnect its external power supply.</li> <li>Check whether the communication cables are loose.</li> </ul>
CMU fault/ alarm	A Rack fault/alarm occurs	Check the fault details on the CMU information page.
DC/AC power converter unit (PCS) fault/ alarm	A DC/AC power converter unit fault/ alarm occurs	<ul style="list-style-type: none"> <li>Check the details of the DC/AC power converter unit fault.</li> <li>Resolve the fault by referring to the section "DC/AC Power Converter Unit Troubleshooting".</li> </ul>
Node fault/ alarm	The node input signal is different from the default signal configuration (configurable)	<ul style="list-style-type: none"> <li>Perform inspections according to the node fault/alarm list.</li> <li>Check the connections of the signal cables.</li> </ul>
Thermal runaway pre-alarm fault	The thermal runaway pre-alarm device triggers a pre-alarm signal, or the pre-alarm device is faulty.	The fault is cleared when the thermal runaway pre-alarm device does not report any pre-alarm signal and no communication fault exists.

Fault	Fault Cause	Suggestions
Thermal runaway pre-alarm device communication fault	There is a communication fault between the thermal runaway pre-alarm device and the LC.	<ul style="list-style-type: none"> <li>• Test the communication line between the LC and the thermal runaway pre-alarm device.</li> <li>• The fault is cleared when the communication between the LC and the thermal runaway pre-alarm device is restored.</li> </ul>
SOC upper limit level 1 alarm	The maximum SOC of the Rack is greater than or equal to the SOC upper limit level 1 value.	<ul style="list-style-type: none"> <li>• Check whether the SOC parameters are correctly set.</li> <li>• Try discharging until the SOC drops below the SOC upper limit level 1 recovery value.</li> </ul>
SOC upper limit level 2 alarm	The maximum SOC of the Rack is greater than or equal to the SOC upper limit level 2 value.	<ul style="list-style-type: none"> <li>• Check whether the SOC parameters are correctly set.</li> <li>• Try discharging until the SOC drops below the SOC upper limit level 2 recovery value.</li> </ul>
SOC lower limit level 1 alarm	The minimum SOC of the Rack is less than or equal to the SOC lower limit level 1 value.	<ul style="list-style-type: none"> <li>• Check whether the SOC parameters are correctly set.</li> <li>• Try charging until the SOC exceeds the SOC upper limit level 1 recovery value.</li> </ul>
SOC lower limit level 2 alarm	The minimum online SOC of the Rack is less than or equal to the SOC lower limit level 2 value.	<ul style="list-style-type: none"> <li>• Check whether the SOC parameters are correctly set.</li> <li>• Try charging until the SOC exceeds the SOC upper limit level 2 recovery value.</li> </ul>
Auxiliary sub-device alarm	There is an auxiliary sub-device communication alarm or a liquid cooling unit alarm.	Check the corresponding sub-devices.

\*If the fault persists after troubleshooting, please contact SUNGROW.

# 7 Appendix

## 7.1 Terms

Abbreviation	Definition	Remark
<b>B</b>		
BM	Battery Module	Battery module (or Pack)
BC	Battery Cluster	Battery cluster (or Rack)
BMU	Battery Management Unit	-
CMU	Battery Cluster Management Unit	-
SMU	Battery System Management Unit	-
BMS	Battery Management System	-
BSC	Battery System Controller	-
BCP	Battery Collection Panel	All battery DC inputs are connected to the BCP DC copper bars, which is then transferred to the PCS DC side via the copper bars on the other side of the BCP.
BSP	Battery Power Supply Panel	Provides auxiliary power to devices in the battery (lighting, FSS, etc.)
<b>D</b>		
DC/DC	DC/DC Converter	-
<b>E</b>		
ESS	Energy Storage System	-

Abbreviation	Definition	Remark
EMS	Energy Management System	-
<b>F</b>		
FACP	Fire Host Alarm Control Panel	-
<b>L</b>		
LC	Local Controller	-
LCS	Liquid Cooling System	-
<b>P</b>		
PCS	Power Conversion System	-
PC	Personal Computer	-
<b>S</b>		
SCADA	Supervisory Control and Data Acquisition	-
S/G	Switch Gear	-
SOC	State Of Charge	-
SOH	State Of Health	-
STP	Shielded Twisted Pair	-
<b>U</b>		
UPS	Uninterruptible Power Supply	-

## 7.2 Quality Assurance

When product faults occur during the warranty period, SUNGROW will provide free service or replace the product with a new one.

### Evidence

During the warranty period, the customer shall provide the product purchase invoice and date. In addition, the trademark on the product shall be undamaged and legible. Otherwise, SUNGROW has the right to refuse to honor the quality guarantee.

### Conditions

- After replacement, unqualified products shall be processed by SUNGROW.
- The customer shall give SUNGROW a reasonable period to repair the faulty device.

### Exclusion of Liability

In the following circumstances, SUNGROW has the right to refuse to honor the quality guarantee:

- The free warranty period for the whole machine/components has expired.
- The device is damaged during transport.
- The device is incorrectly installed, refitted, or used.
- The device operates in harsh conditions beyond those described in this manual.
- The fault or damage is caused by installation, repairs, modification, or disassembly performed by a service provider or personnel not from SUNGROW.
- The fault or damage is caused by the use of non-standard or non-SUNGROW components or software.
- The installation and use range are beyond stipulations of relevant international standards.
- The damage is caused by unexpected natural factors.

For faulty products in any of above cases, if the customer requests maintenance, paid maintenance service may be provided based on the judgment of SUNGROW.



Product data such as product dimensions are subject to change without prior notice. The latest documentation from SUNGROW should take precedence in case of any deviation.

## 7.3 Contact Information

In case of questions about this product, please contact us. We need the following information to provide you the best assistance:

- Model of the device
- Serial number of the device
- Fault code/name
- Brief description of the problem

For detailed contact information, please visit: <https://en.SUNGROWpower.com/contactUS>

**SUNGROW**

Sungrow Power Supply Co., Ltd.

[www.sungrowpower.com](http://www.sungrowpower.com)